

IPMS INTERNATIONAL
PROPERTY
MEASUREMENT
STANDARDS

www.ipmsc.org

International Property Measurement Standards: **All Buildings**

International Property Measurement Standards Coalition



International Property Measurement Standards: All Buildings

International Property Measurement Standards Coalition

15 January 2023

Published by the International Property Measurement Standards Coalition (IPMSC).

No responsibility for loss or damage caused to any person acting or refraining from action as a result of the material included in this publication can be accepted by the authors or IPMSC.

ISBN: 978-0-6454191-1-5

Copyright © 2022 International Property Measurement Standards Coalition (IPMSC). All rights reserved. Copies of this document may be made strictly on condition that they acknowledge IPMSC's copyright ownership, set out the IPMSC's web address in full, www.ipmsc.org, and do not add to or change the name or the content of the document in any way.

This document should not be translated, in whole or in part, and disseminated in any media, whether by electronic, mechanical or other means now known or hereafter invented, including photocopying or recording, or in any information storage and retrieval system, without permission in writing from the IPMSC.

Please address publication and copyright matters to contact@ipmsc.org

Contents

Welcome to IPMS: All Buildings	1
Part A: Introduction	2
Part B: Principles of IPMS Selection, Measurement Practice and Reporting	3
B.1 Standard Selection	3
B.2 Measurement Practice and Calculation	3
B.3 Reporting	3
Part C: Definitions	4
Part D: Technical	6
D.1 Overview – Component Areas	6
D.2 Internal Dominant Face	11
D.3 Limited Use Areas	12
D.4 Height	12
D.5 Bay Windows	13
D.6 External Floor Area	14
D.7 Notional Boundary	14
D.8 Sheltered Area	15
D.9 Demising Wall	15
Part E IPMS Standards	16
E.1 IPMS 1	16
E.2 IPMS 2	20
E.3 IPMS 3 (IPMS for Exclusive Use Areas)	23
E.3.1 IPMS 3.1 (Exclusive Occupation External Measurement)	24
E.3.2 IPMS 3.2 (Exclusive Occupation Internal Measurement)	28
E.4 IPMS 4 – IPMS for Selected Floor Areas	32
E.4.1 IPMS 4.1	33
E.4.2 IPMS 4.2	35
Part F: IPMS Coalition	37
Part G: IPMS Standards Setting Committee	39

Welcome to IPMS: All Buildings

On behalf of the IPMS Coalition we present IPMS: All Buildings.

The Coalition comprises organisations from around the world that have come together to create one shared international standard for property measurement. There has been a lack of consistent measurement standards within many markets: our profession and consumers deserve better.

IPMS: All Buildings follows feedback from previous consultations and discussions with many stakeholders over inconsistencies about measurement of office, industrial, residential and retail property within and across markets.

As a Coalition we have continued the important work of implementation through engaging with governments, occupiers, owners and other important stakeholders. You can view the list of well over 200 companies and governments that have committed to using IPMS at www.ipmsc.org



Paul Bagust,

Trustee for RICS,

Chair of the Board of Trustees IPMS
Coalition



Maurice Barbieri,

Trustee for FIG,

Vice Chair of the Board of Trustees IPMS
Coalition



Ron Cohen,

Trustee for Israel IVS Forum,

Secretary General of the Board of
Trustees IPMS Coalition

Part A: Introduction

IPMS All Buildings supersedes all previously published IPMS standards for individual asset classes by utilising the concepts and objectives contained in those specific versions of IPMS into one harmonised standard. *IPMS All Buildings* is applicable to all types of [Buildings](#) independent of their use or their occupation.

IPMS are sufficiently flexible to apply to different purposes such as:

- Analysis and Benchmarking
- Construction Cost Rates and Ratios
- Conversion between Measurement Standards
- Cost Allocation
- Insurance
- Planning and Architecture
- Property Development
- Property Financing
- Property Management
- Research
- Summary Costing
- Sustainability & Energy Efficiency
- Valuation/Transactions (incl: leasing and sales)

IPMS have the flexibility to measure only part of a building or to holistically measure all the areas in the building and allocate these areas into separate components. This flexibility provides a common language that can interface with pre-existing local measurement standards.

IPMS adopt unique nomenclature to avoid confusion with existing terms that are unfortunately used inconsistently in markets across the world. The IPMS structure and interface with other measurement standards is demonstrated by the flow chart shown below.

IPMS have been composed to enable the selection of the appropriate basis of measurement so that there may not be a need to review the whole document to apply the measurement but only to have regard to the specific standard to suit the market needs. IPMS are divided into three (3) fundamentally different groupings as shown below:

1. [IPMS 1](#) and [IPMS 2](#) are external and internal measurements respectively for the whole or part of a [Building](#).
2. [IPMS 3.1](#) and [IPMS 3.2](#) are external and internal measurements respectively required for exclusive occupation.
3. [IPMS 4.1](#) and [IPMS 4.2](#) are internal measurements required for selected areas respectively including [Internal Walls](#) and [Columns](#) and excluding [External Walls](#) and [Columns](#).

For ease of reference the Standards Setting Committee (SSC) has named the various standards using the IPMS prefix to make the nomenclature IPMS 1, IPMS 2, IPMS 3.1, IPMS 3.2, IPMS 4.1 and IPMS 4.2 more user friendly.

The use of [Component Areas](#) is optional, but they facilitate the analysis of a [Building](#) and can also be used to convert between IPMS and other measurement standards.

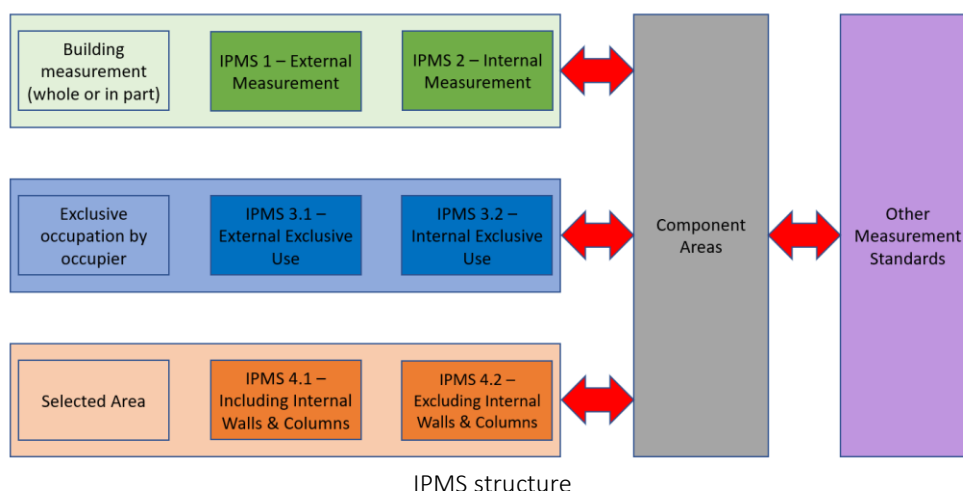

Diagrams within IPMS do not reflect a particular asset class and the sole purpose of each diagram is to depict the principles of the IPMS concept.

Part B: Principles of IPMS Selection, Measurement Practice and Reporting

B.1 Standard Selection

IPMS are designed to satisfy the needs of the market by focusing on the purposes to which measurements can be applied. IPMS, however, do not dictate the purpose or its use. IPMS can be used for any purpose where the measurement and reporting of a measured area is required or essential to provide accurate accounting of space within a [Building](#). To use the IPMS:

1. Identify the purpose of the measurement; then
2. Select the appropriate IPMS for that purpose; and then
3. Apply the measurement practice for the selected IPMS.

B.2 Measurement Practice and Calculation

IPMS adopts the following fundamental measurement and calculation practices:

1. Measurements and calculations should be in the unit of measurement commonly adopted in the relevant jurisdiction.
2. All measurements, with the exception of height, are to be taken horizontally.
3. IPMS measurement should be supported by computer-generated drawings if available but, where other drawings are used as a basis for measurement, annotated dimensions on drawings should be used in preference to a reliance on scaling alone.
4. Where possible, measurements should be independently verified on site.
5. Measurement and computing processes must be sufficiently accurate to satisfy the requirements and the purpose to which the measurement is to be used.
6. [Buildings](#) or selected areas are to be measured individually on a level by level basis.
7. When faced with situations not explicitly addressed by IPMS, the principles are to be extrapolated using a logical and consistent approach, based on these fundamental principles and supported by an explanation.

B.3 Reporting

1. The principles of measurement and calculation along with the measurements reported must be clearly documented and the following stated:
 - the use of the [Building](#) or part of the [Building](#), if mixed use;
 - the standard used, for example, [IPMS 1](#), [IPMS 2](#), [IPMS 3.1](#), [IPMS 3.2](#), [IPMS 4.1](#) or [IPMS 4.2](#);
 - the method of measurement and the tools used;
 - the unit of measurement;
 - the date of the measurement; and
 - whether the measurement has been verified on site and the way it was validated.
2. [Buildings](#) or selected areas are to be reported on a level by level basis.
3. Measurements may be required to be converted between imperial and metric, in which case the conversion factor must be stated.
4. IPMS adopt Level 0 as the ground level entrance. If there is more than one ground floor entrance, due for instance to a sloping site, Level 0 is the main ground level entrance. Floors above are described as Level 1, 2 and 3 etc. and floors below are described as Level -1, -2 and -3 etc.
5. Where dual reporting is adopted, reconciliation between IPMS and the standard referred to must be appropriately referenced. Consideration should be given to existing legally defined boundaries.

Part C: Definitions

The definitions contained below and elsewhere in this document are terms used in the IPMS and are only applicable to the interpretation and application of the IPMS. These definitions do not attempt to define basic real estate terms, as users of IPMS are assumed to have an understanding of such terms. Where a defined term is included in the IPMS, it is shown in Title Case and with a link to the definition in the IPMS.

Balustrade

A protective barrier such as a [Wall](#), parapet, railings or other construction feature that enables [Floor Area](#) with one or more open sides to be used safely. See [Part D.6](#)

Boundary

A physical, non-physical or legal line denoting the perimeter of an area to be measured.

Building

A construction providing shelter from the environment for occupants or contents, partially or totally enclosed by a roof, designed to stand in one place and comprising all levels within the construction.

Clear Height

The height within a level of a [Building](#) or section of a [Building](#) measured from the floor surface to the lowest point of the structural element above, ignoring the existence of any brackets, struts or fixtures and fittings. See [Part D.4](#)

Column

A [Building](#) member (may also be known as a Pillar), generally cylindrical or rectangular in shape and having a maximum ratio of 4:1, comparing the longest and shortest horizontal dimensions, whose primary purpose is to provide structural support. (If the ratio is greater than 4:1, the element is treated as a [Wall](#).)

Component

One of the main elements into which the [Floor Area](#) of a [Building](#) can be allocated.

Component Area

The [Floor Area](#) attributed to one of the [Components](#).

Covered Area

The extent of the area of a [Building](#) covered by one or more roofs, the perimeter of which is sometimes referred to as the drip line, being the outermost permanent structural extension, exclusive of ornamental overhangs.

Demising Wall

A [Wall](#), other than an [External Wall](#), between adjoining occupiers' space or an occupier's space and Standard Facilities. See [Part D.9](#)

External Floor Area

An external horizontal structure at any floor level of a [Building](#) with a [Balustrade](#) to the open sides, including generally accessible balconies, colonnades (with [Balustrade](#)), rooftop terraces, external galleries and loggias but excluding structures such as patios and terraces when not integral to the structural construction of the [Building](#).

External Wall

The enclosing element of a [Building](#), excluding appendages and ornamental features, which separates the interior area from the exterior.

Finished Surface

The [Wall](#) surface directly above the horizontal wall-floor junction, ignoring any part-height walls, cladding, fittings, skirting boards, cable-trunking, pipework and heating or cooling units.

Floor Area

The area of a normally horizontal, permanent, load-bearing structure, inclusive of areas occupied by [Walls](#), [Columns](#), stairs, staircase openings, lift shafts and other vertical penetrations, for all or part of each level of a [Building](#).

Internal Dominant Face (IDF)

The inside surface area comprising more than 50 per cent of the lowest 2.75 m measured vertically from the structural floor surface, or to the ceiling if lower, for each [Wall Section](#). If such does not occur or if the [Wall Section](#) is not vertical, the [Finished Surface](#) is deemed to be the IDF. See [Part D.2](#)

Internal Height

The height within a [Building](#) or section of a [Building](#) measured from the floor to the lowest point of a ceiling, suspended ceiling, or similar defining feature. See [Part D.4](#)

Internal Wall

A full-height [Wall](#) within a [Building](#) that separates one interior area from another.

Mezzanine

An intermediate or partial floor that is usually fully or partially open on one or more sides.

Notional Boundary

A non-physical line that forms part or all of a [Boundary](#) and is typically agreed as part of the measurement instruction or defined by a legal document. See [Part D.7](#)

Secondary Area

A demised area forming part of the [Building](#) that supports the primary use of an exclusive use area.

Sheltered Area

Any part of the [Covered Area](#) that is not fully enclosed where the permanent structural extension above provides effective shelter. See [Part D.8](#)

Standard Facilities

Shared areas in a [Building](#) that typically do not change over time, such as circulation areas, stairs, escalators, lifts/elevators and their motor rooms, toilets, cleaners' cupboards, plant rooms, fire refuge areas and maintenance rooms.

Wall

A normally vertical element, whether or not load-bearing, that separates one area from another.

Wall Section

The lateral portion of an [External Wall](#), where the inside finished surface area of each part of a window, [Wall](#) or other external construction feature varies from the adjoining lateral portion of [External Wall](#), ignoring the existence of any [Columns](#). See [Part D.2](#)

Part D: Technical

D.1 Overview – Component Areas

All [Building](#) areas can be divided into [Components](#). The use of [Component Areas](#) is optional.

[Component Areas](#) should be applied when areas need to be separately allocated for purposes such as benchmarking, comparison and analysis and may be applied for conversion between IPMS applications or other measurement standards.

D.1.1 Use of the Component Areas

[Component Areas](#) are horizontal areas within a [Building](#) which are designated according to their structure and function.

The sum of all the [Component Areas](#) will equal [IPMS 1](#) for the [Building](#) or level of a [Building](#) being measured. When using [Component Areas](#), in addition to the IPMS measurement practices, the following steps must be applied:

1. Determine the area to be componentised (i.e. whole or part of a [Building](#)).
2. Allocate the area into the main [Component Areas](#).
3. Further allocate the [Component Areas](#) into sub-component areas to the extent required.
4. [Component Areas](#) may also be allocated according to exclusive or shared use or allocated between enclosed space and [External Floor Areas](#).
5. In mixed-use [Buildings](#), [Components](#) may be subdivided according to the primary use, before allocating to the main and sub-component areas.

D.1.2 Other Considerations

A portion of a [Floor Area](#) that can be allocated to more than one [Component Area](#) should be allocated to the [Component Area](#) that best reflects the main use (e.g. changing room and washroom).

Non-enclosed floor openings such as piping, conduits or vents of less than 0.1 m² are disregarded and the area is included in the surrounding [Component Area](#).

[Component Areas](#) may be customised according to the measurement instruction.

D.1.3 Measurement Reporting

If a [Component Area](#) has more than one use, the area should be allocated according to its dominant use.

Any reported [Component Areas](#) should, where practical and appropriate, be cross-referenced to an appropriately coloured drawing and [Component Area](#) spreadsheet.

Table 1: IPMS Defined Component Areas for a Building

Component Area A (Columns, Walls and Notional Boundaries)	Sub-Component Area A1	Notional Boundary
		The area between the Notional Boundary and the External Wall .
	Sub-Component Area A2	External Structural Elements
		The External Wall area between the outside face and the IDF .
	Sub-Component Area A3	Inter-Surface Adjustment
		The Wall area between the IDF and the Finished Surface .
Sub-Component Area A4	Internal Structural Elements	
	Internal Walls , internal Columns and internal structures.	
Sub-Component Area A5	Internal Non-Structural Elements	
	Balustrades , if located within the measured floor area, full-height Internal Walls and similar non-structural elements other than those included in Component Area A1, A2 and A3. For Demising Walls this sub-component may be further subdivided.	
Component Area B Vertical Penetration Areas	Sub-Component Area B1	Vertical Circulation Areas
		Staircase openings, stairs, lift / elevator shafts and escalators.
Sub-Component Area B2	Vertical Technical Areas	
	Service shafts and ducts equal to or greater than 0.1 m ² .	
Component Area C Technical Areas	Component Area C	Technical Areas
		Mechanical and electrical plant rooms, lift / elevator motor rooms and maintenance rooms.
Component Area D Sanitary Areas	Component Area D	Sanitary Areas (Standard Facilities)
		Toilet facilities, cleaners'/janitors' cupboards, bath/shower rooms and changing rooms.
Component Area E Circulation Areas	Component Area E	Horizontal Circulation Areas (Standard Facilities)
		Circulation areas whether or not enclosed.

Component Area F Primary Areas	Component Area F	Primary Areas
		Areas used for primary purposes such as industrial, office, residential or retail. Primary areas that include sanitary areas and horizontal circulation areas, which form part of the occupant’s fitout, may be sub-componentised, where not included in Component Areas D and E.
Component Area G Secondary Areas	Sub-Component Area G1	Amenity Areas
		Areas for the benefit of the primary purpose such as exclusive food court seating areas, exercise or child-minding facilities.
	Sub-Component Area G2	Ancillary Areas
		Areas for the benefit of the primary purpose such as exclusive delivery areas, refuge areas and car parking that form part of the Building .
Component Area H Other Areas	Sub-Component Area H1	Other Areas (General)
		All other areas included in IPMS 1 but not otherwise included in Component Areas A–G and Sub-Component Areas H2 and H3 which may include External Floor Area(s) and Sheltered Area(s) .
	Sub-Component Area H2	Other Area (Construction)
		Areas, such as the area between the Balustrade and the outside edge of the floor construction.
	Sub-Component Area H3	Other Areas (Standard Facilities)
		Landlord-provided Standard Facilities such as food court seating areas, exercise or child-minding facilities or other Standard Facilities such as delivery areas, refuge areas and car parking.

Component Area Examples

Please note that examples of the [Component Areas](#) shown in the Diagrams 1 and 2 below are for illustrative purposes only. Other [Component Areas](#) could be similarly treated and may vary according to the layout, use or occupation of the [Building](#).

Diagram 1 - Component Areas – Level 0

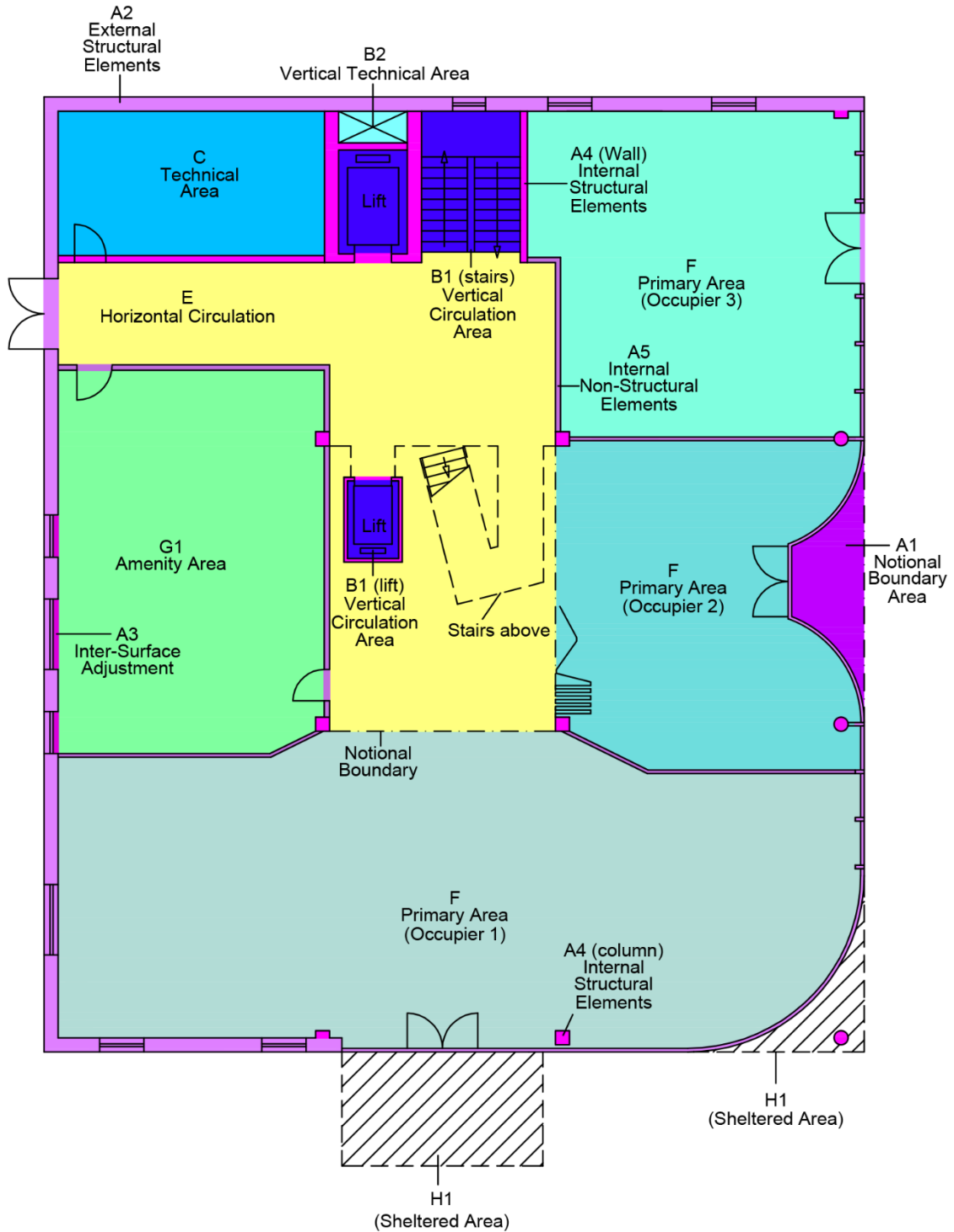
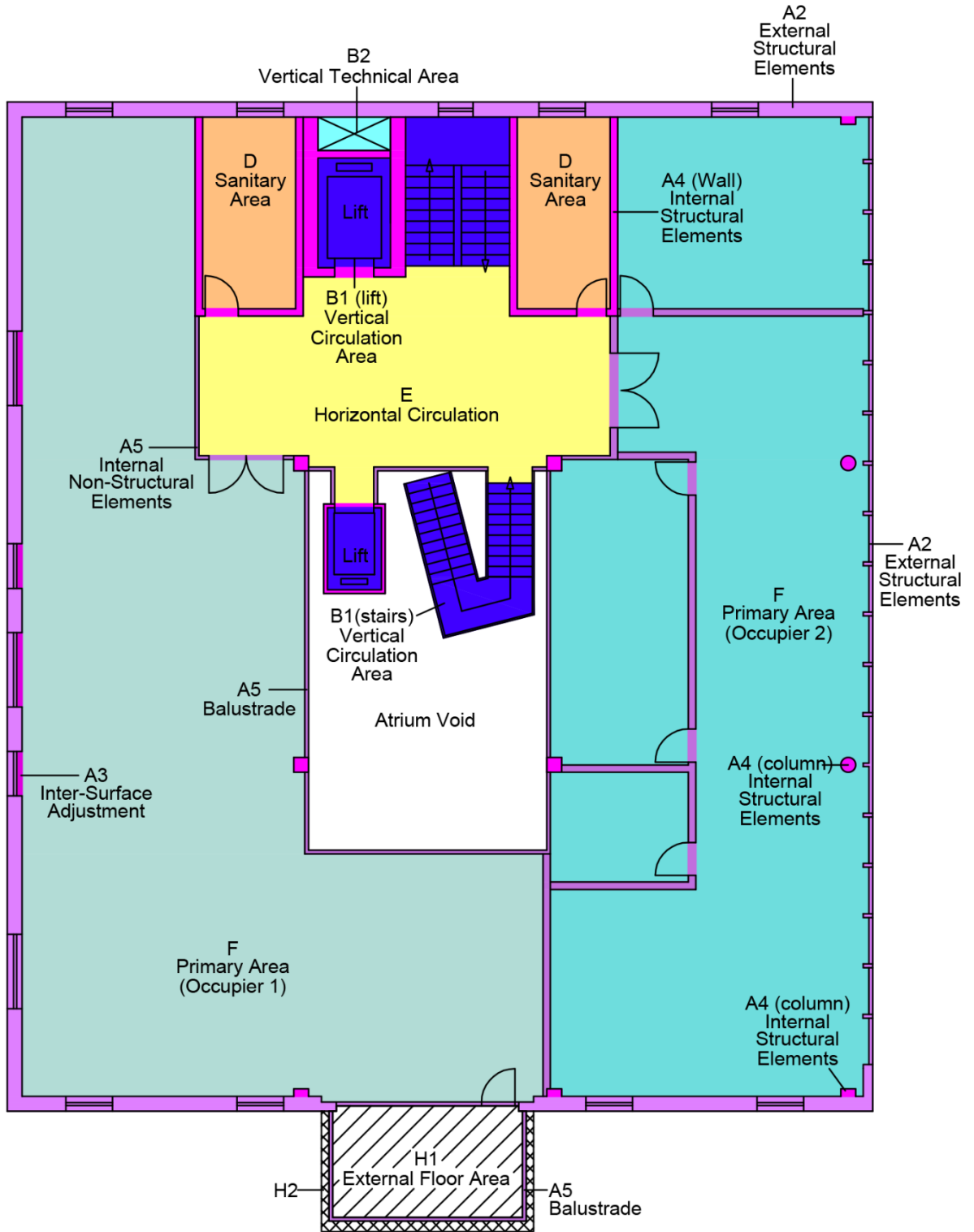

Diagram 2 - Component Areas – Upper Level



D.2 Internal Dominant Face

The [Internal Dominant Face \(IDF\)](#) is the inside surface area comprising more than 50 per cent of the lowest 2.75 m measured vertically from the structural floor surface, or to the ceiling if lower, for each [Wall Section](#). If such does not occur or if the [Wall Section](#) is not vertical, the [Finished Surface](#) is deemed to be the [IDF](#).

A [Wall Section](#) is the lateral portion of an [External Wall](#), where the inside finished surface area of each part of a window, [Wall](#) or other external construction feature varies from the adjoining lateral portion of [External Wall](#) ignoring the existence of any [Columns](#).

Diagram 3 - Internal Dominant Face (IDF)

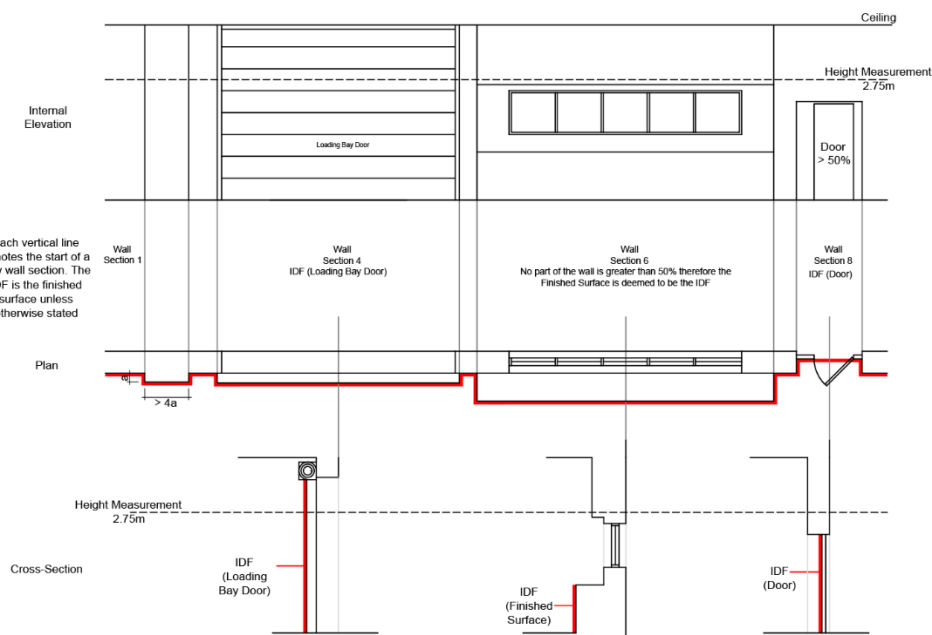
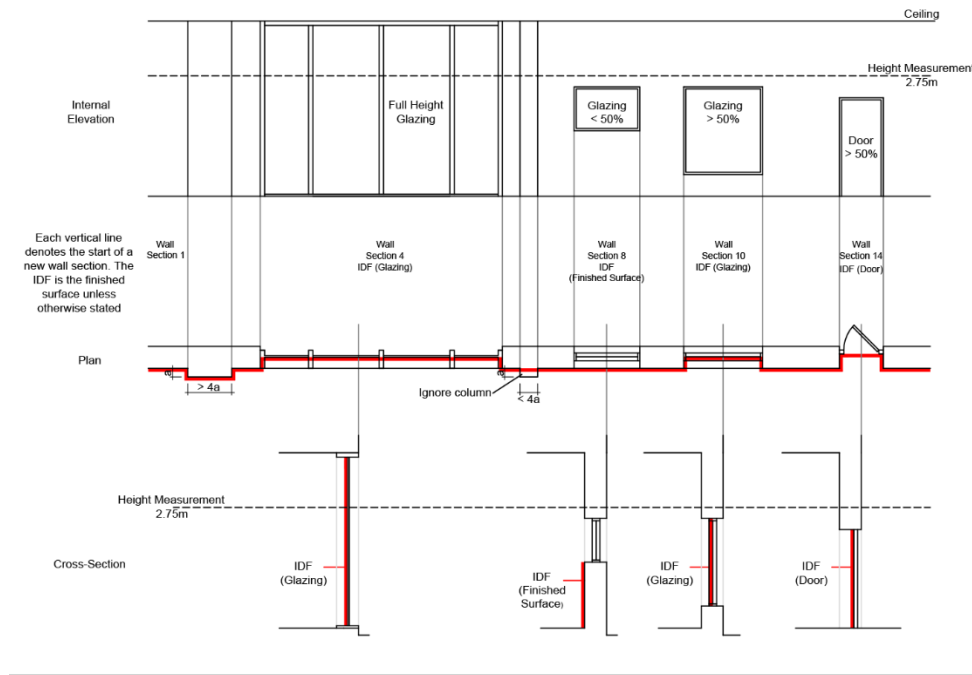

D.3 Limited Use Areas

In certain markets there may be areas in [Buildings](#) that are incapable of legal or effective occupation due to local or national legislation, such as areas with lack of natural light or practical circumstances such as height restrictions.

Measurements stated in IPMS include any limited use area and the reason for each limitation should be identified and stated separately: for example, a total IPMS area of $x \text{ m}^2$ (including $y \text{ m}^2$ for each separately stated limited use area).

The inclusion of measured areas in IPMS does not necessarily mean that the areas are available for legal occupation or use.

D.4 Height

In some instances, the measurement of height is required for reporting, including for volumetric calculations. In order to create consistency, where vertical measurements are often open to different interpretations, IPMS provides the following measurement practices.

Clear Height

The height within a level of a [Building](#) or section of a [Building](#) measured from the floor surface to the lowest point of the structural element above, ignoring the existence of any brackets, struts or fixtures and fittings.

Diagram 4 - Clear Height

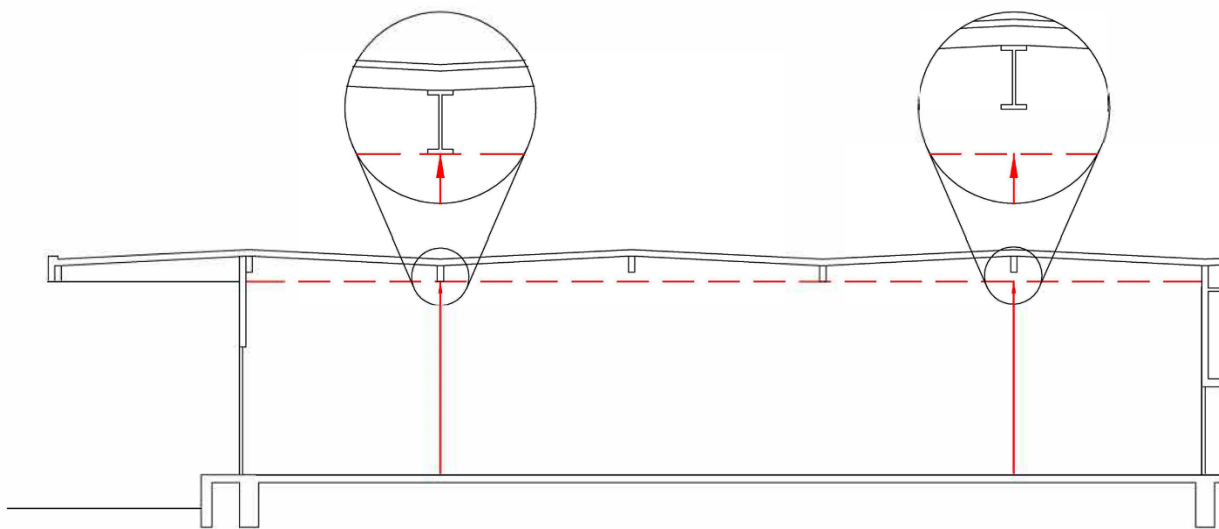

The red dashed line denotes the top of the Clear Height measurement

Internal Height

The height within a [Building](#) or section of a [Building](#) measured from the floor to the lowest point of a ceiling, suspended ceiling or similar defining feature.

Diagram 5 - Internal Height

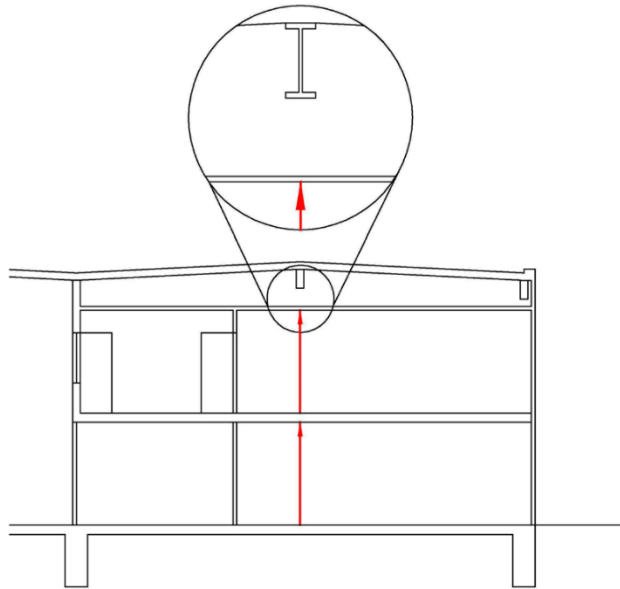

D.5 Bay Windows

The external extent of the [External Wall](#) is assumed to be the vertical [Boundary](#) at the floor level. The area occupied by the bay window is included in all IPMS areas and the [Boundaries](#) follow the practices set out in each IPMS area. Bay windows may be regarded as a limited use area.

Diagram 6 - Bay Window

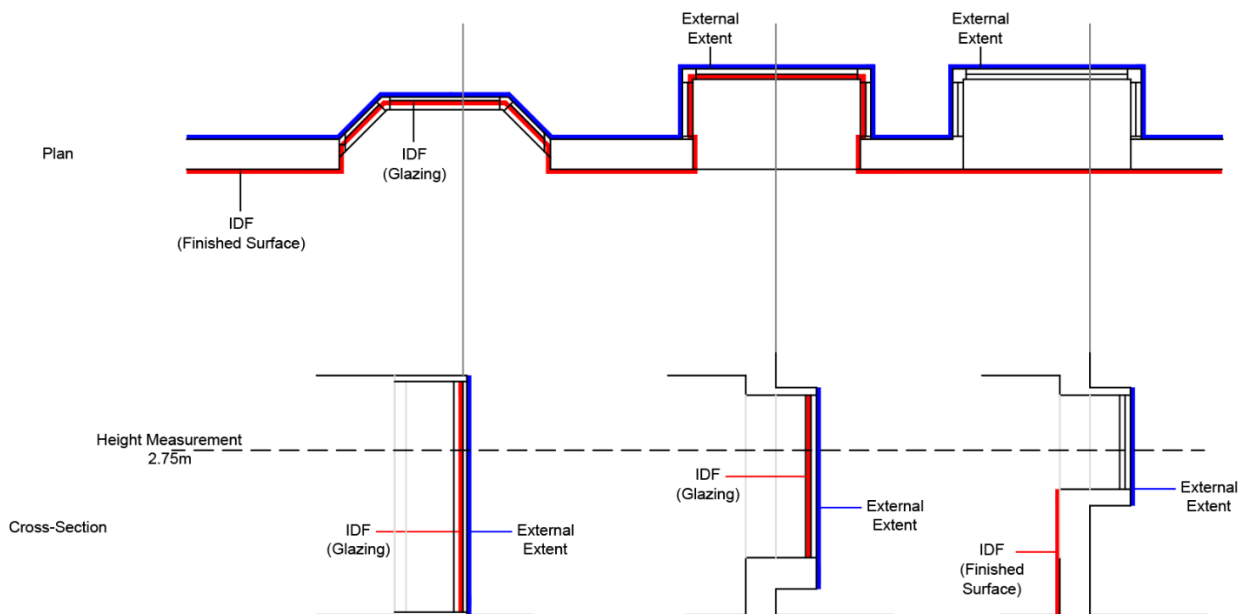

D.6 External Floor Area

The [External Floor Area](#) and [Mezzanine](#) measurements vary according to the IPMS measurement used.

IPMS Measurement	Balustrade Boundary	External Wall Boundary
IPMS 1	Outside edge of Floor Construction	IPMS 1 External Wall boundary
IPMS 2	Floor – Balustrade Junction	IPMS 1 External Wall boundary
IPMS 3.1	Floor – Balustrade Junction	IPMS 1 External Wall boundary
IPMS 3.2	Floor – Balustrade Junction	IPMS 1 External Wall boundary
IPMS 4.1	Floor – Balustrade Junction	IPMS 1 External Wall boundary
IPMS 4.2	Floor – Balustrade Junction	IPMS 1 External Wall boundary

Diagram 7 - External Floor Area and Mezzanine – IPMS 1

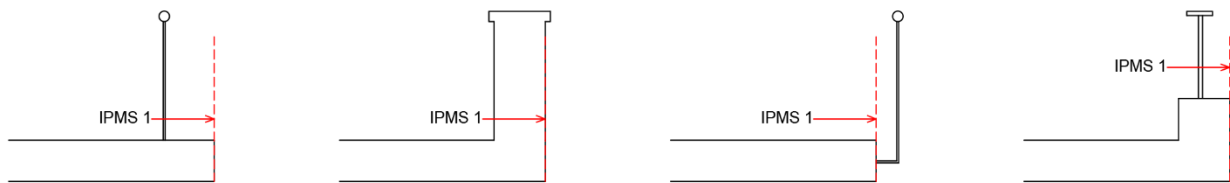
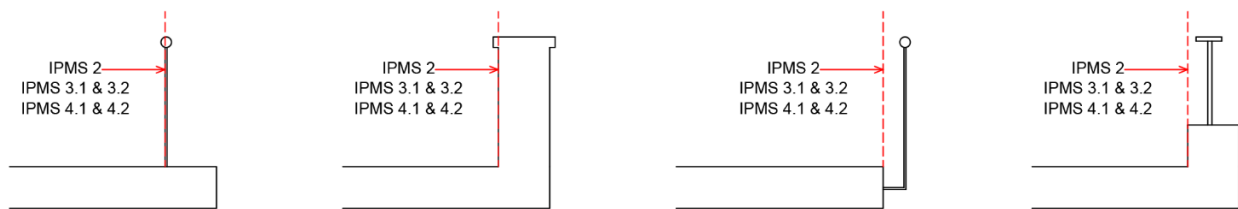

Diagram 8 - External Floor Area and Mezzanine – IPMS 2, 3.1, 3.2, 4.1 & 4.2



D.7 Notional Boundary

The [Notional Boundary](#) is a non-physical line that forms part or all of a [Boundary](#) and is typically agreed as part of the measurement instruction or defined by a legal document. Under IPMS any agreed [Notional Boundaries](#) that differ from the maximum physical extent of [External Floor Areas](#), [Sheltered Areas](#) or [External Walls](#) must be identified.

Diagram 9 - Notional Boundary

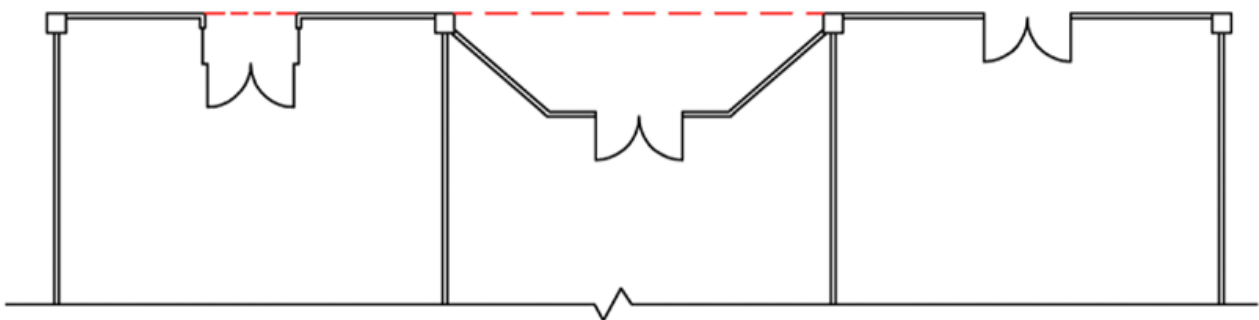

D.8 Sheltered Area

Sheltered Areas comprise any part of the Covered Area that is not fully enclosed where the permanent structural extension above provides effective shelter. Under IPMS any Sheltered Areas must be identified, and a Boundary line must be established along the edge of the permanent structural extensions directly above.

Diagram 10 - Sheltered Area

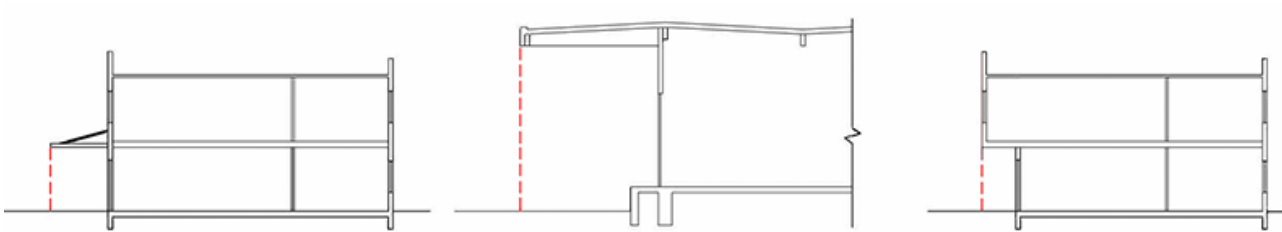

D.9 Demising Wall

A Demising Wall is a Wall, other than an External Wall, between adjoining occupiers' space or an occupier's space and Standard Facilities. The Demising Walls between adjoining occupiers' space is measured to the centreline of the Wall. The Boundary line between an occupier's space and Standard Facilities is measured to the Finished Surface.

Diagram 11 - Demising Wall

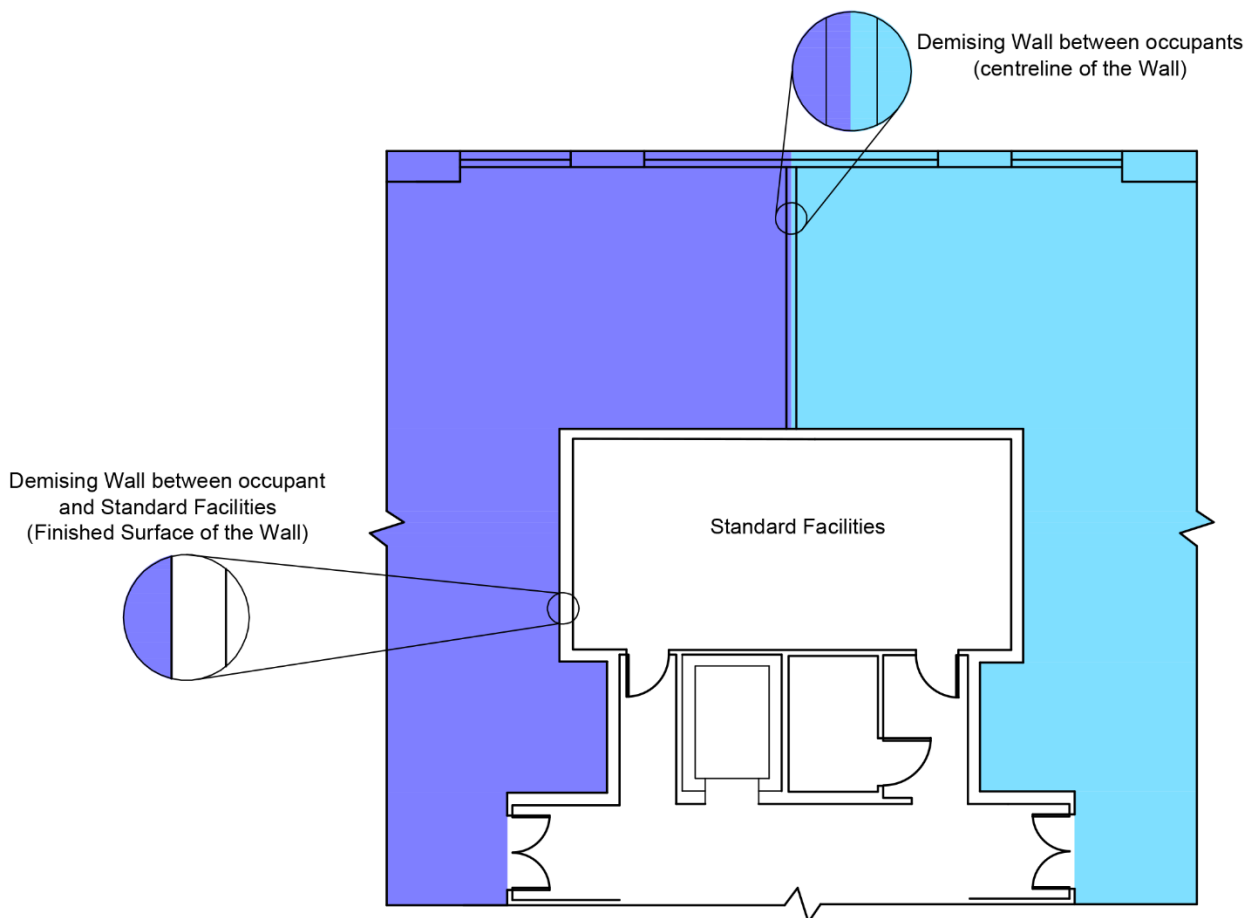

The example shown above reflects IPMS 3.1.

Part E IPMS Standards

E.1 IPMS 1

IPMS 1 – Definition

The [Floor Area](#) measured to the external extent of the [External Walls](#) and to any [Notional Boundaries](#) (see [Diagram 9](#)), [External Floor Areas](#) (see [Diagram 7](#)) or [Sheltered Areas](#) (see [Diagram 10](#)).

E.1.1 IPMS 1 - Measurement Practice

Stage 1: Determine the IPMS 1 Boundary

The [Boundary](#) of IPMS 1 for each level is determined by the considering the following in sequential order.

1. Notional Boundary

Identify any agreed [Notional Boundaries](#) that differ from the maximum physical extent of [External Floor Areas](#), [Sheltered Areas](#) or [External Walls](#).

2. External Floor Area

Identify [External Floor Areas](#) which are measured to the outside edge of the floor construction, and up to the IPMS 1 [External Wall Boundary](#).

3. Sheltered Area

Identify any [Sheltered Areas](#) and establish a [Boundary](#) line along the edge of the permanent structural extensions directly above.

4. External Wall

Identify the remaining [Boundary](#) line along the maximum physical extent of the [External Wall](#).

Stage 2: Other Considerations

Measurements are taken to the centreline of shared [External Walls](#) between adjoining [Buildings](#).

The areas occupied by [Walls](#) and [Columns](#) within the [Boundary](#) are not deducted.

Where the wall thickness of any [External Wall](#) is unknown, an estimate should be made and stated.

Void areas such as covered air and stair openings and atria within a [Building](#) are excluded but the [Floor Area](#) at the lowest level of air and stair openings and atria is included.

External stairs that lead to upper levels are included, except open framework fire escapes which are excluded.

Measurement of the upper levels of a void and [Mezzanines](#) (see [Diagram 7](#)) is the same as for [External Floor Area](#), that is to the outside edge of the floor construction.

Access openings, such as roller shutters and folding doors in an [External Wall](#), are ignored when establishing the external [Boundary](#) line.

Structures beyond the [Covered Area](#) do not form part of the [Building](#). If measured, they must be stated as separate [Building\(s\)](#).

Stage 3: Measure and Calculate the Areas Included in IPMS 1

Once the IPMS [Boundary](#) for each level of the [Building](#) has been determined, the [Boundary](#) lines should be measured and the area within the [Boundary](#) calculated on a level by level basis and/or may be apportioned into different sections of the area being measured. The resulting calculations determine the IPMS 1 for each level or section and these are added together to calculate IPMS 1 for the [Building](#). Any reporting of IPMS 1 must state whether it is for the entire [Building](#) or only for one or more levels of the [Building](#).

Stage 4: Areas Included in IPMS 1 but Reported Separately

The following areas are included in [IPMS 1](#) but, for completeness and clarity, must be itemised individually on a level by level basis:

- Any area between a [Notional Boundary](#) and the external perimeter of [External Walls](#);
- [Sheltered Areas](#);
- [External Floor Areas](#);
- Enclosed walkways or passages connecting separate [Buildings](#);
- Enclosed rooftop plant such as mechanical, electrical and lift motor rooms;
- External stairs that lead to upper levels, excluding open framework fire escapes, which are excluded;
- Limited use area(s) not otherwise identified above.

Diagram 12 - IPMS 1 – Level 0

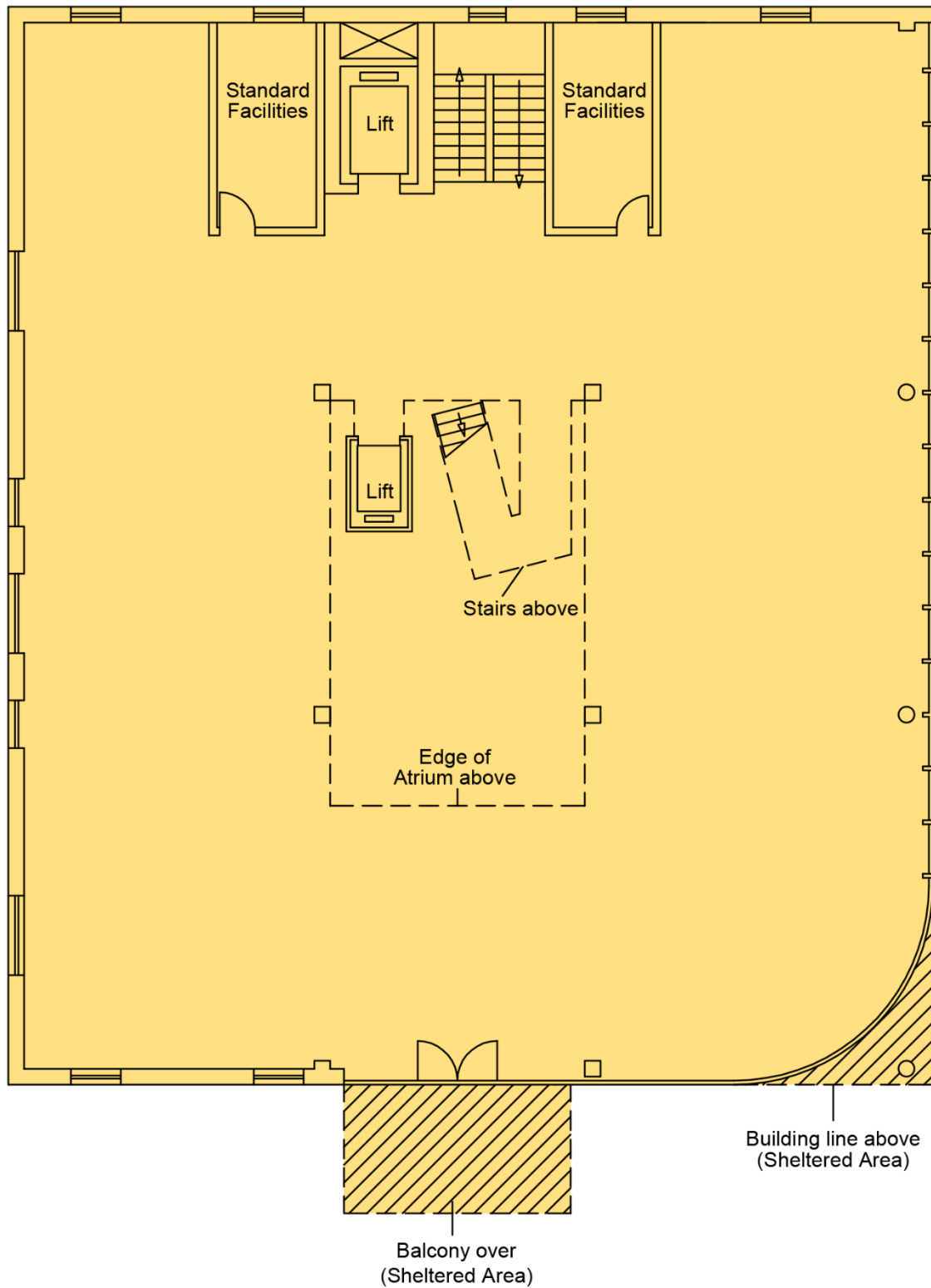
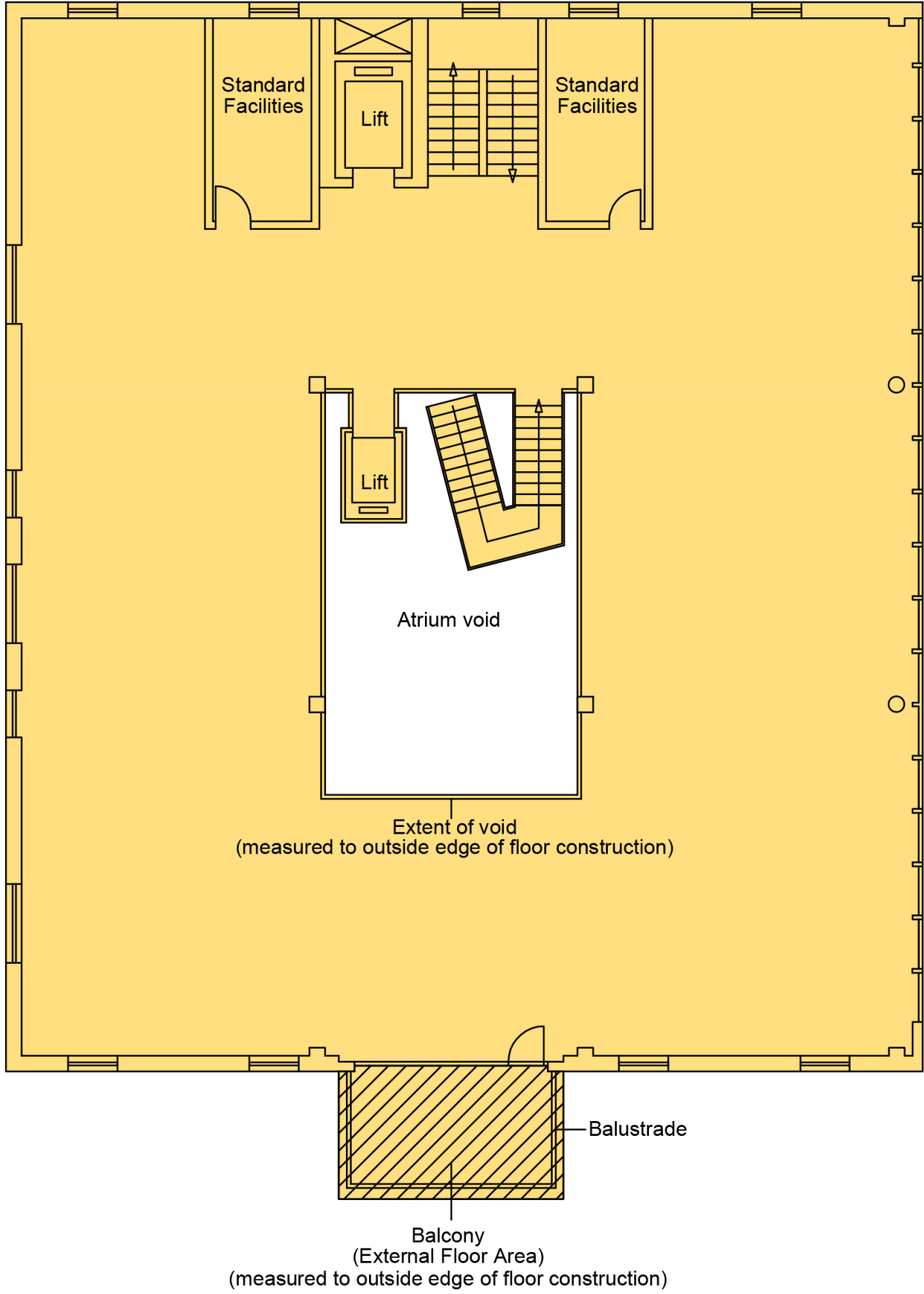

Diagram 13 - IPMS 1 – Upper Level



E.2 IPMS 2

E.2.1 IPMS 2 – Definition

The [Floor Area](#) measured to the internal extent of the [IDF](#) (see [Diagram 3](#)) and to any [Notional Boundaries](#) (see [Diagram 9](#)) and [External Floor Areas](#) (see [Diagram 8](#)).

E.2.2 IPMS 2 - Measurement Practice

Stage 1: Determine the IPMS 2 Boundary

The [Boundary](#) of IPMS 2 for each level is determined by considering the following in sequential order:

1. Notional Boundary

Identify any agreed [Notional Boundaries](#) that differ from the [IDF](#) or [External Floor Area](#);

2. External Floor Area

Identify any [External Floor Areas](#) and establish [Boundary](#) lines along the floor-[Balustrade](#) junction, but not beyond the outside edge of the floor construction and up to the [IPMS 1 External Wall Boundary](#);

3. Internal Dominant Face (IDF)

Identify the [IDF](#) line of all [External Walls](#).

Stage 2: Other Considerations

Measurements are taken to the [IDF](#) of shared [External Walls](#) (i.e. [Demising Walls](#)) between adjoining [Buildings](#).

The areas occupied by [Walls](#) and [Columns](#) within the [Boundary](#) are not deducted.

Void areas such as covered air and stair openings and atria within a [Building](#) are excluded but the [Floor Area](#) at the lowest level of air and stair openings and atria is included.

Measurement of the upper levels of a void and [Mezzanines](#) (see [Diagram 8](#)) is treated the same as for [External Floor Area](#), that is to the floor-[Balustrade](#) junction, but not beyond the outside edge of the floor construction.

The wall thickness between the [External Floor Area](#) and the [IDF](#) is excluded from IPMS 2.

[Sheltered Areas](#) and other areas that are not within the structural construction of a [Building](#), such as patios and other external facilities are excluded from IPMS 2. If measured, they must be stated separately.

Stage 3: Measure and calculate the areas included in IPMS 2

Once the IPMS 2 [Boundary](#) for each level of the [Building](#) has been determined, the [Boundary](#) lines should be measured and the [Floor Area](#) within the [Boundary](#) calculated on a level by level basis and/or may be apportioned into different sections of the area being measured. The area of any atrium void above the lowest level is deducted at each level. The resulting calculations determine the IPMS 2 for each level or section and these are added together to calculate the IPMS 2 for the [Building](#). Any reporting of IPMS 2 must state whether it is for the entire [Building](#) or only for one or more levels or sections of the [Building](#).

Stage 4: Areas Included in IPMS 2 but Reported Separately

The following areas are included in IPMS 2, but for completeness and clarity must be itemised individually on a level by level basis:

- Any area between a [Notional Boundary](#) and the [Internal Dominant Face](#);
- [External Floor Areas](#);
- [Mezzanines](#);
- Enclosed walkways or passages connecting separate [Buildings](#);
- Enclosed roof-top plant rooms such as mechanical, electrical and lift equipment rooms/elevator machine rooms;
- Limited use area(s) not otherwise identified above.

Diagram 14 - IPMS 2 – Level 0

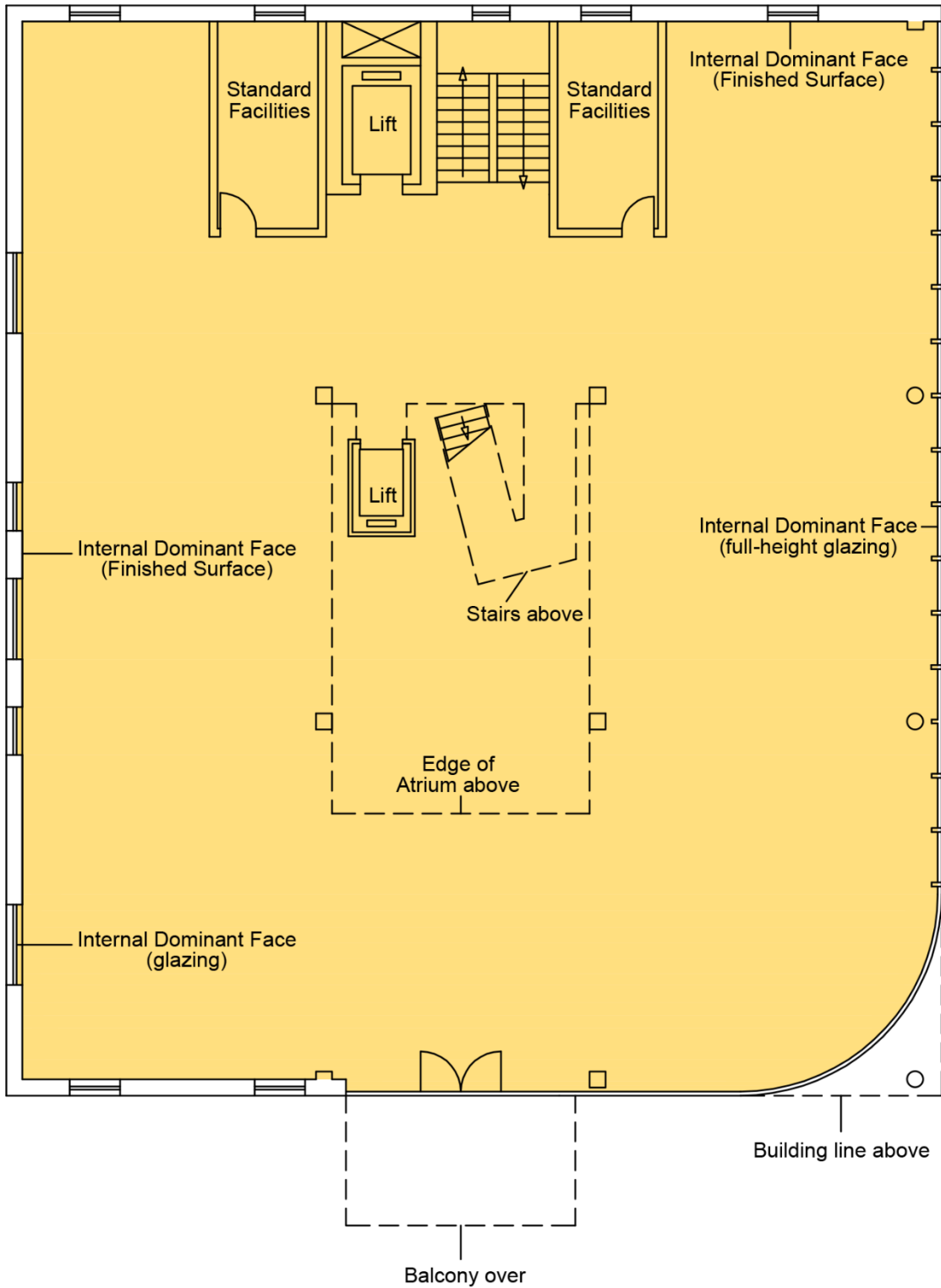
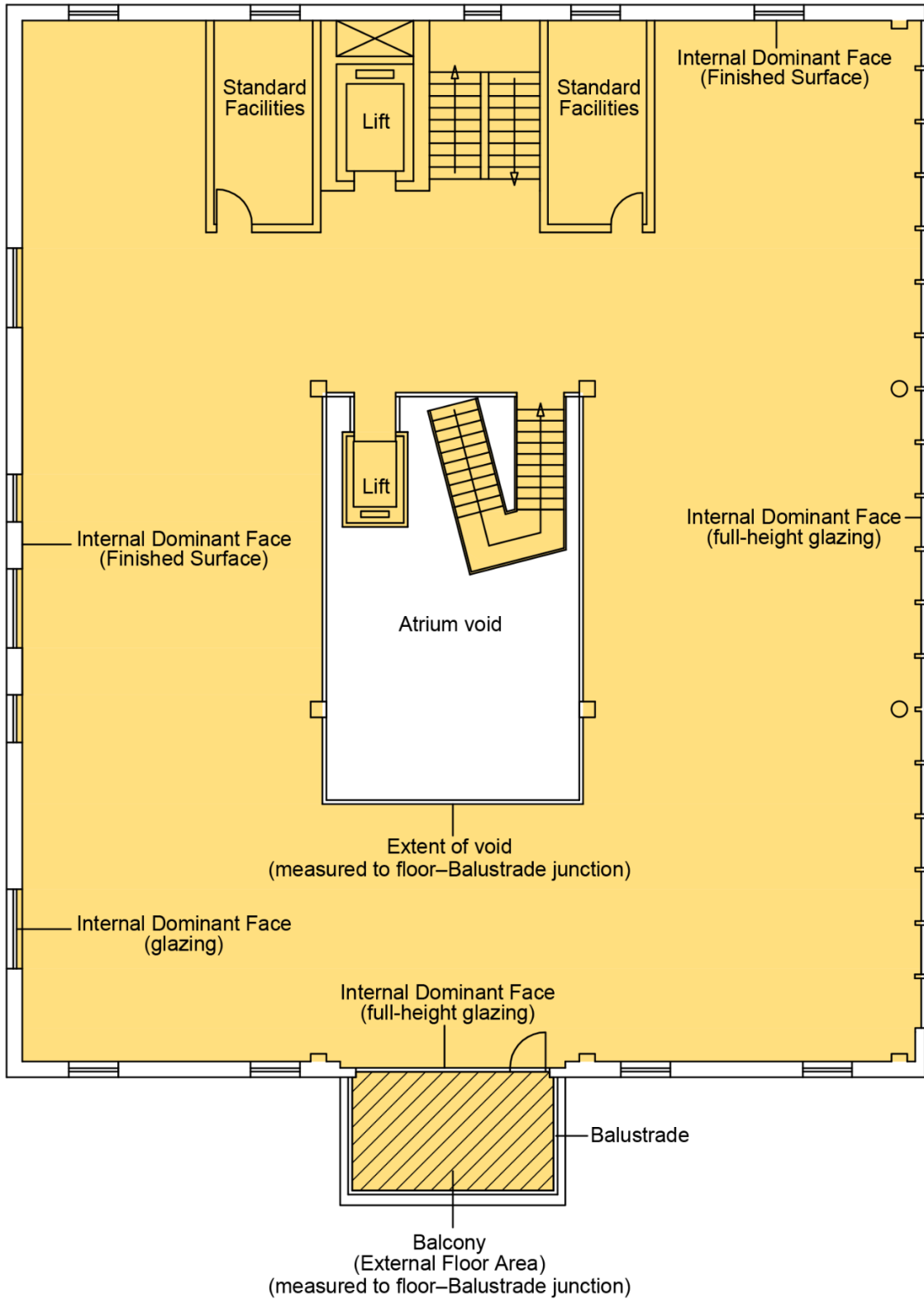

Diagram 15 - IPMS 2 – Upper Level



E.3 IPMS 3 (IPMS for Exclusive Use Areas)

IPMS 3 – Overview

Measurement references must state whether the measurement is [IPMS 3.1](#) or [IPMS 3.2](#) and not simply IPMS 3.

Each exclusive occupancy area in a multi-occupied [Building](#) must be measured separately and level by level. If consistently applied, the total of relevant exclusive occupancy areas may be reported as an aggregate of [IPMS 3.1](#) or [IPMS 3.2](#) for the [Building](#).

[IPMS 3.1](#) and [IPMS 3.2](#) are not directly related to [IPMS 1](#), [IPMS 2](#), [IPMS 4.1](#) or [IPMS 4.2](#).

E.3.1 IPMS 3.1 (Exclusive Occupation External Measurement)

E.3.1.1 IPMS 3.1 – Definition

The [Floor Area](#) available on an exclusive basis to an occupier measured externally to any [Notional Boundaries](#) (see [Diagram 9](#)), [External Walls](#), [Demising Walls](#) (see [Diagram 11](#)) and including any [External Floor Areas](#) (see [Diagram 8](#)), [Sheltered Areas](#) (see [Diagram 10](#)) and [Secondary Areas](#).

E.3.1.2 IPMS 3.1 - Measurement Practice

Stage 1: Determine the IPMS 3.1 Boundary

The [Boundary](#) of IPMS 3.1 for each level is determined by considering the following in sequential order:

1. Notional Boundary

Identify any agreed [Notional Boundaries](#) that differ from the maximum physical extent of [External Floor Areas](#), [Sheltered Areas](#), [External Walls](#) or [Demising Walls](#).

2. External Floor Area

Identify any [External Floor Areas](#) and establish [Boundary](#) lines along the floor-[Balustrade](#) junction, but not beyond the outside edge of the floor construction and then and up to the [IPMS 1 External Wall Boundary](#).

3. Sheltered Area

Identify any [Sheltered Areas](#) and establish a [Boundary](#) line along the edge of the permanent structural extensions directly above.

4. External Wall

Identify the remaining [Boundary](#) line along the maximum physical extent of the [External Wall](#).

5. Demising Wall

Identify the [Boundary](#) line along the centreline of any [Demising Walls](#) between occupants or adjoining [Buildings](#) and identify the [Boundary](#) line along the [Finished Surface](#) of other [Demising Walls](#), for example between the occupier's area and [Standard Facilities](#).

6. Secondary Areas

Consistent with the above, identify the [Boundary](#) lines of any [Secondary Areas](#), such as seating or storage areas for the primary area not directly connected to the primary area.

Stage 2: Other Considerations

Tenant-related non-permanent changes are disregarded.

The areas occupied by [Walls](#) and [Columns](#) within the [Boundary](#) are not deducted.

Where the wall thickness of any [External Wall](#) is unknown an estimate should be made and stated.

Void areas such as covered air and stair openings and atria within a [Building](#) are excluded but the [Floor Area](#) at the lowest level of air and stair openings and atria is included.

Measurement of the upper levels of a void and [Mezzanines](#) (see [Diagram 8](#)) is treated the same as [External Floor Area](#), that is, to the floor-[Balustrade](#) junction, but not beyond the outside edge of the floor construction.

Access openings, such as roller shutters and folding doors, in an [External Wall](#) are ignored when establishing the external [Boundary](#) line.

External stairs that lead to upper levels are included, except open framework fire escapes which are excluded.

The [Floor Area](#) occupied by [Standard Facilities](#) is excluded.

Structures beyond the [Covered Area](#) that do not form part of the [Building](#) being measured are excluded, but if measured, they must be stated separately and individually.

Stage 3: Measure and Calculate the Areas Included in IPMS 3.1

Once the [IPMS 3.1 Boundary](#) for each level of the [Building](#) has been determined, the [Boundary](#) lines should be measured and the [Floor Area](#) within the [Boundary](#) calculated on a level by level basis. The resulting calculations determine the [IPMS 3.1](#) for each level and these are added together to calculate [IPMS 3.1](#) for the occupier's exclusive area.

[IPMS 3.1](#) for a multi-occupied [Building](#) is the aggregate of each occupier's exclusive use area.

Stage 4: Areas Included in IPMS 3.1 but Reported Separately

The following areas, if in exclusive occupation, are included in [IPMS 3.1](#) but, for completeness and clarity, must be itemised individually on a level by level basis:

- [Sheltered Areas](#);
- [External Floor Areas](#);
- Enclosed walkways or passages connecting separate [Buildings](#), which form part of occupier's area;
- [Mezzanines](#);
- Vertical technical penetrations with openings equal to or greater than 0.1m² and their surrounding [Walls](#);
- Limited use area(s) not otherwise identified above.

Diagram: 16 - IPMS 3.1 – Single Occupancy – Upper Level

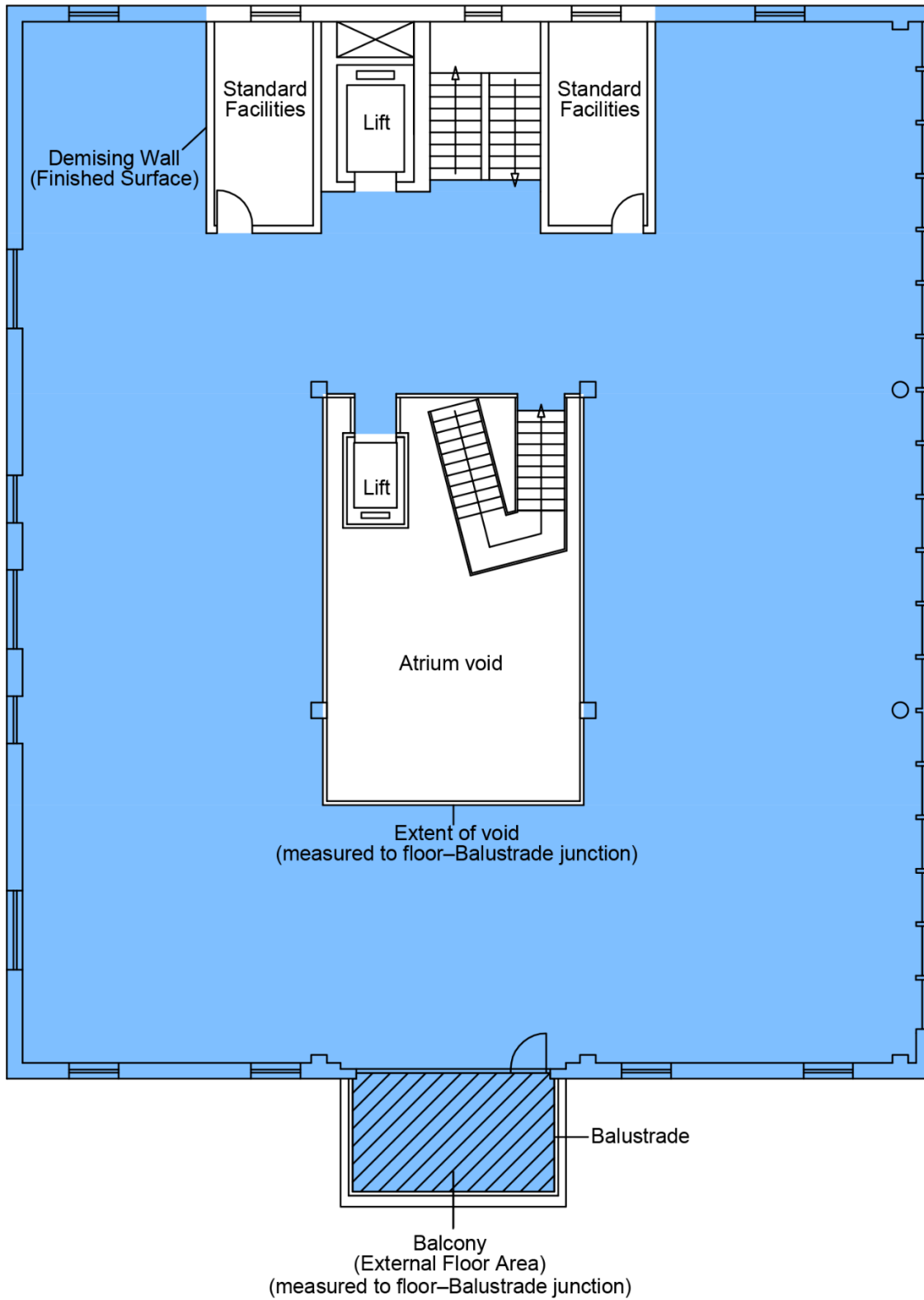
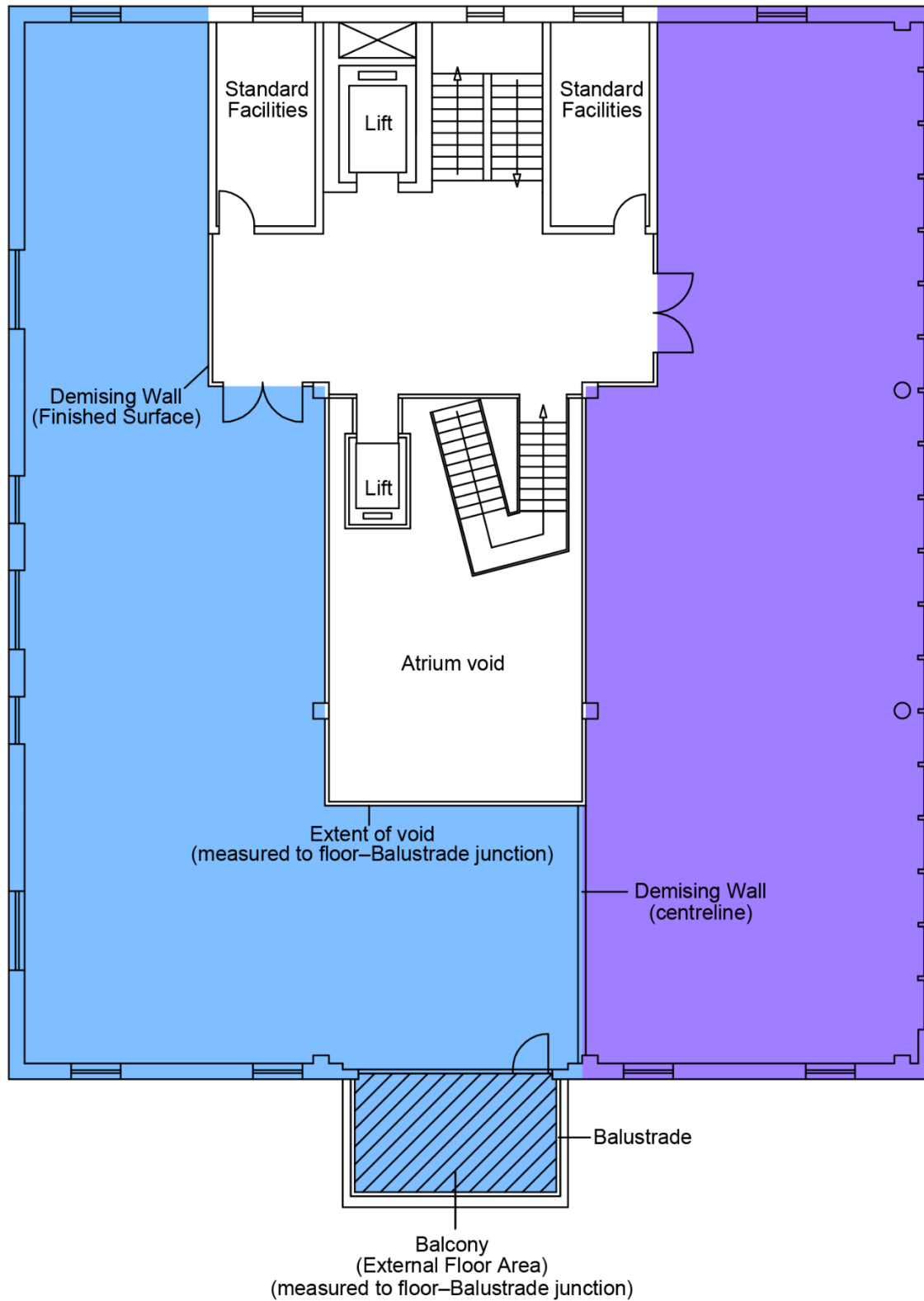

Diagram 17 - IPMS 3.1 – Multiple Occupancy – Upper Level



E.3.2 IPMS 3.2 (Exclusive Occupation Internal Measurement)

E.3.2.1 IPMS 3.2 – Definition

The [Floor Area](#) available on an exclusive basis to an occupier measured internally to any [Notional Boundaries](#) (see [Diagram 9](#)), the [Internal Dominant Face](#) (see [Diagram 3](#)), [Demising Walls](#) (see [Diagram 11](#)) and including any [External Floor Areas](#) (see [Diagram 8](#)), [Sheltered Areas](#) (see [Diagram 10](#)) and [Secondary Areas](#).

E.3.3.3 IPMS 3.2 - Measurement Practice

Stage 1: Determine the IPMS 3.2 Boundary

The [Boundary](#) of IPMS 3.2 for each level is determined by considering the following in sequential order:

1. **Notional Boundary**

Identify any agreed [Notional Boundaries](#) that differ from an [IDF](#) or the extent of any [External Floor Areas](#) or [Sheltered Areas](#).

2. **External Floor Area**

Identify any [External Floor Areas](#) and establish [Boundary](#) lines along the floor-[Balustrade](#) junction, but not beyond the outside edge of the floor construction and up to the [IPMS 1 External Wall Boundary](#).

3. **Sheltered Area**

Identify any [Sheltered Areas](#) and establish [Boundary](#) lines along the edge of the permanent structural extensions above.

4. **Internal Dominant Face (IDF)**

Identify the [Boundary](#) lines along the [IDF](#) of all [External Walls](#) or [Demising Walls](#).

5. **Demising Wall**

Identify the [Boundary](#) along the centreline of [Demising Walls](#) between occupants and identify [Boundary](#) lines along the [Finished Surface](#) of other [Demising Walls](#), for example between the occupier's areas and [Standard Facilities](#).

6. **Secondary Areas**

Consistent with the above, identify the [Boundary](#) lines of [Secondary Areas](#), such as seating or storage areas for the primary area not directly connected to the main occupied area.

Stage 2: Other Considerations

Tenant-related non-permanent changes within a [Building](#) are disregarded.

Measurements are taken to the [IDF](#) of shared [External Walls](#) between adjoining [Buildings](#).

The areas of [Walls](#) and [Columns](#) within the [Boundary](#) are not deducted.

Void areas such as covered air and stair openings and atria within a [Building](#) are excluded but the [Floor Area](#) at the lowest level of air and stair openings and atria is included.

IPMS 3.2 measurements ignore recessed door and lift openings in internal structural walls and continue the [Finished Surface Boundary](#) line.

Measurement of [Mezzanines](#) (see [Diagram 10](#)) and upper floor levels is treated the same as [External Floor Areas](#), that is, to the floor-[Balustrade](#) junction but not beyond the outside edge of the floor construction.

The [Floor Area](#) occupied by [Standard Facilities](#) is excluded.

[External Floor Areas](#) are measured to the innermost line at the top of the [Balustrade](#), but not beyond the outside edge of the floor construction, then up to the [IPMS 1 Boundary](#) of the [External Walls](#).

The wall thickness between any [External Floor Areas](#) and the [IDF](#) is excluded from [IPMS 3.2](#).

[Sheltered Areas](#) are measured up to the [IPMS 1 Boundary](#) of [External Walls](#).

Structures beyond the [Covered Area](#) that do not form part of the [Building](#) being measured are excluded. If measured, they must be stated separately and individually.

Stage 3: Measure and Calculate the Areas Included in IPMS 3.2

Once the [IPMS 3.2 Boundary](#) for each level of the [Building](#) has been determined, the [Boundary](#) lines should be measured and the [Floor Area](#) within the [Boundary](#) calculated on a level by level basis. The resulting calculations determine the [IPMS 3.2](#) for each level and these are added together to calculate [IPMS 3.2](#) for the occupier's exclusive area.

[IPMS 3.2](#) for a multi-occupied [Building](#) is the aggregate of each occupier's exclusive use area.

Stage 4: Areas Included in IPMS 3.2 but Reported Separately

The following areas, if in exclusive occupation, are included in [IPMS 3.2](#) but, for completeness and clarity, must be itemised individually on a level by level basis:

- [Sheltered Areas](#);
- [External Floor Areas](#);
- Enclosed walkways or passages connecting separate [Buildings](#), which form part of occupier's exclusive area;
- [Mezzanines](#);
- Vertical technical penetrations with openings equal to or greater than 0.1m² and their surrounding [Walls](#);
- Limited use area(s) not otherwise identified above.

Diagram 18 - IPMS 3.2 – Single Occupancy – Upper Level

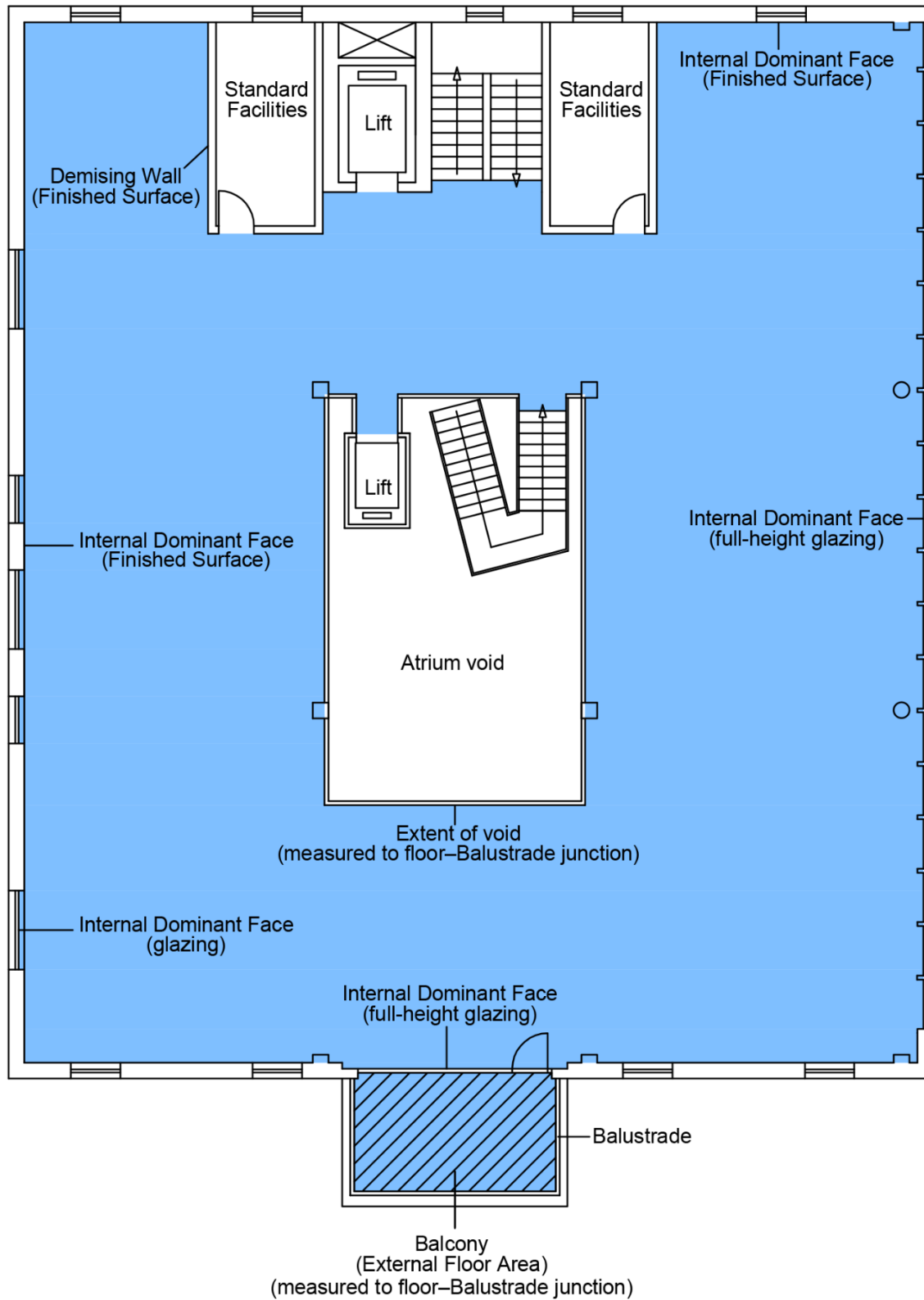
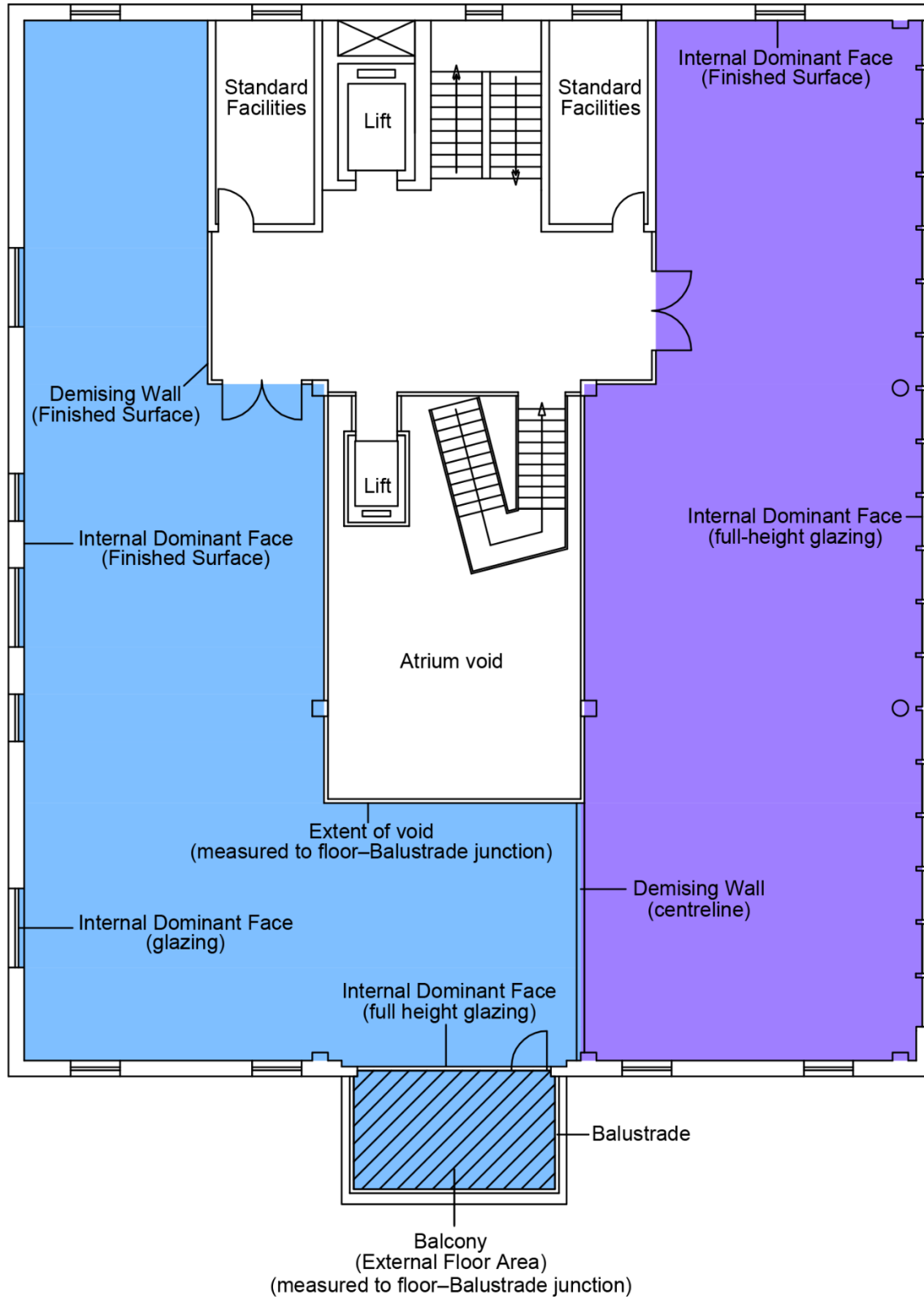

Diagram 19 - IPMS 3.2 – Multiple Occupancy – Upper Level



E.4 IPMS 4 – IPMS for Selected Floor Areas

IPMS 4 – Overview

[IPMS 4.1](#) and [IPMS 4.2](#) are used for measuring [Floor Areas](#) of selected parts within a [Building](#). Such measurements are directly linked to specific defined criteria. These measurements may include some selected parts or even all of the [Building](#).

[IPMS 4.1](#) and [IPMS 4.2](#) are measured to the [Finished Surface](#).

Examples of a potential selected part(s) of a [Building](#) are shown below:

- the extent of air-conditioned against non-air-conditioned space;
- how much space has a security restriction;
- the size of a hotel suite;
- the ratio between the front of house and back of house in a hotel;
- the ratio of different uses within a [Building](#);
- defining and verifying a client space requirement;
- the area of departments within an organisation's space;
- the area required given a desired density of occupancy;
- the size of a maternity wing in a hospital;
- the horizontal and vertical circulation areas within a building;
- room areas within a residence.

The purpose for which the measurement is to be used must be clearly stated and the [Boundary](#) selected for an [IPMS 4.1](#) and an [IPMS 4.2](#) measurement must be clearly stated and/or identified on a plan.

While [IPMS 4.1](#) and [IPMS 4.2](#) are measured to the [Finished Surface](#), the principles of measurement are the same as for other IPMS measurements.

E.4.1 IPMS 4.1

E4.1.1 IPMS 4.1 – Definition

The selected [Floor Area](#) in a [Building](#) measured to [Finished Surfaces](#) and to any [Notional Boundaries](#) (see [Diagram 9](#)), [External Floor Area](#) (see [Diagram 8](#)) and [Sheltered Area](#) (see [Diagram 10](#)) including all [Floor Area](#) occupied by [Walls](#) and [Columns](#).

IPMS 4.1.2 - Measurement Practice

Stage 1: Determine the IPMS 4.1 - Boundary

The [Boundary](#) of IPMS 4.1 for each level is determined by considering the following in sequential order.

1. Notional Boundary

Identify any agreed [Notional Boundaries](#) that differ from a [Finished Surface](#) or the extent of any [External Floor Areas](#) or [Sheltered Areas](#).

2. External Floor Area

Identify any [External Floor Areas](#) and establish [Boundary](#) lines along the floor-[Balustrade](#) junction, but not beyond the outside edge of the floor construction and then and up to the [IPMS 1 External Wall Boundary](#).

3. Sheltered Area

Identify any [Sheltered Areas](#) and establish a [Boundary](#) line along the edge of the permanent structural extensions directly above.

4. Finished Surface

Identify the [Boundary](#) line along the [Finished Surface](#) of the internal perimeter [Walls](#) and [External Walls](#).

Stage 2: Other Considerations

If a [Notional Boundary](#) rather than a [Finished Surface](#) is adopted, for example in allocating space in an open-plan area, then it has to be clearly identified in any reporting.

IPMS 4.1 measurements ignore recessed door and lift openings in the [Boundary](#) lines and continue the [Finished Surface Boundary](#) line, unless specifically included in the selected area.

Measurement of [Mezzanines](#) (see [Diagram 8](#)) and upper floor levels where there is a void is treated the same as for [External Floor Areas](#).

Stage 3: Measure and Calculate the Areas Included in IPMS 4.1

Once the [Boundary](#) lines have been determined, they should be measured and the area of IPMS 4.1 calculated.

Stage 4: Areas Included in IPMS 4.1 but Must be Reported Separately

The following areas, if included in IPMS 4.1, must be itemised individually on a level by level basis for purposes of completeness and clarity:

- [External Floor Areas](#);
- [Sheltered Areas](#);
- [Secondary Areas](#);
- Limited use areas;
- Stairs;
- Staircase openings;
- Lift shafts;
- Other vertical penetrations.

Diagram 20 - IMPS 4.1 – Upper Level

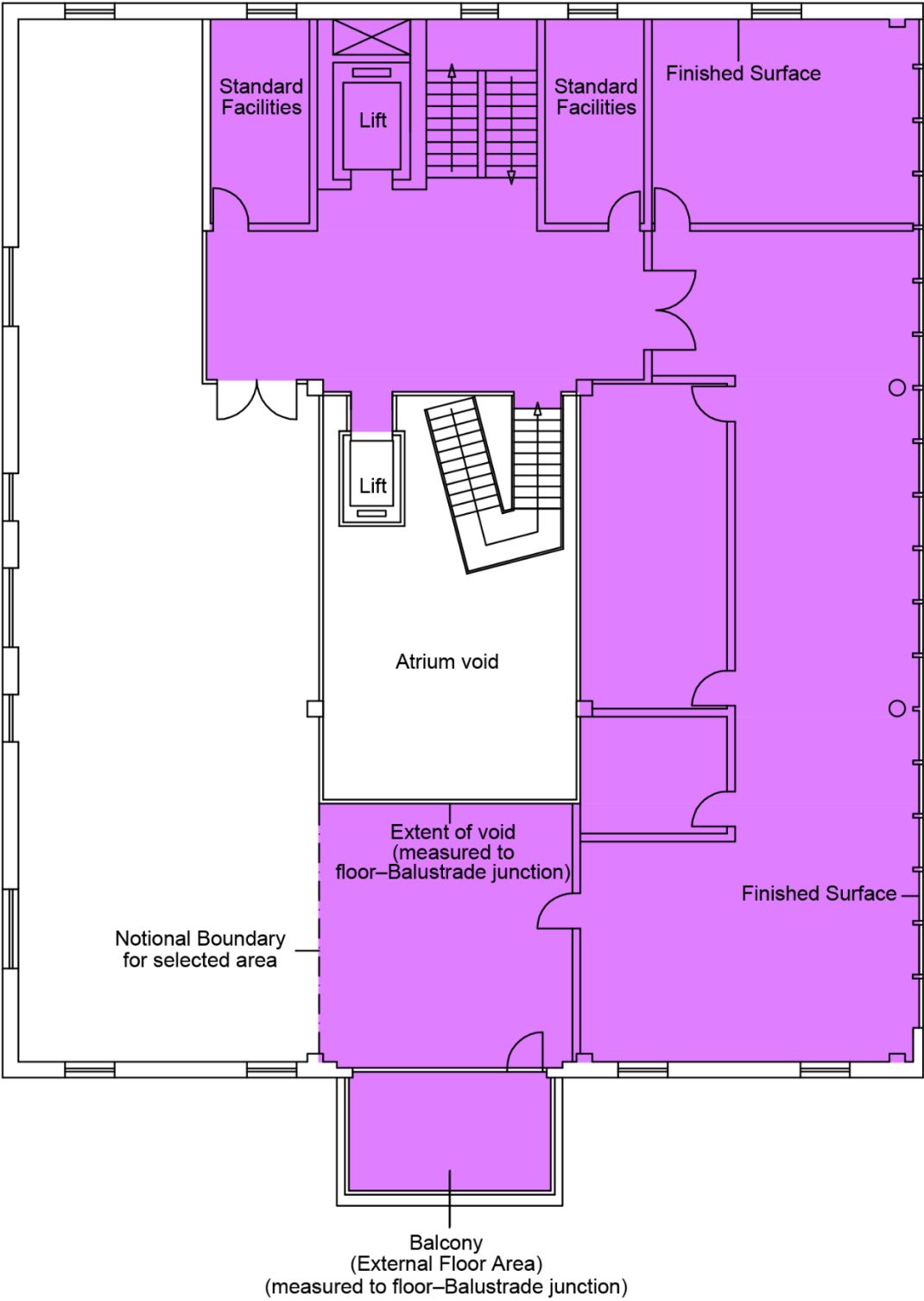

E.4.2 IPMS 4.2

E.4.2.1 IPMS 4.2 – Definition

The selected [Floor Area](#) in a [Building](#) measured to [Finished Surfaces](#) and to any [Notional Boundaries](#) (see [Diagram 9](#)), [External Floor Area](#) (see [Diagram 8](#)) and [Sheltered Area](#) (see [Diagram 10](#)) but excluding (subtracting) all [Floor Area](#) occupied by [Walls](#) and [Columns](#).

E.4.2.2 IPMS 4.2 - Measurement Practice

Stage 1: Determine the IPMS 4.2 Boundary

The [Boundary](#) of IPMS 4.2 for each level is determined by considering the following in sequential order.

1. Notional Boundary

Identify any [Notional Boundaries](#) that differ from a [Finished Surface](#) or the extent of any [External Floor Areas](#) or [Sheltered Areas](#).

2. External Floor Area

Identify any [External Floor Areas](#) and establish [Boundary](#) lines along the floor-[Balustrade](#) junction, but not beyond the outside edge of the floor construction and up to the [IPMS 1 External Wall Boundary](#).

3. Sheltered Area

Identify any [Sheltered Areas](#) and establish [Boundary](#) lines along the edge of the permanent structural extensions directly above.

4. Finished Surface

Identify the [Boundary](#) line along the [Finished Surface](#) of the internal perimeter [Walls](#) and [External Walls](#).

Stage 2: Other Considerations

If a [Notional Boundary](#) rather than a [Finished Surface](#) is adopted, for example in allocating space in an open-plan area, then it has to be clearly identified in any reporting.

IPMS 4.2 measurements ignore recessed door and lift openings in the [Boundary](#) lines and continue the [Finished Surface Boundary](#) line, unless specifically included in the selected area.

Measurement of [Mezzanines](#) (see [Diagram 8](#)) and upper floor levels where there is a void is the same as for [External Floor Areas](#).

Stage 3: Measure and Calculate the Areas Included in IPMS 4.2

Once the [Boundary](#) lines have been determined they should be measured, and the area of IPMS 4.2 calculated.

Stage 4: Areas that are Included in IPMS 4.2 but Must be Reported Separately

The following areas if included in IPMS 4.2, must be itemised individually for purposes of completeness and clarity:

- [External Floor Areas](#);
- [Sheltered Areas](#);
- [Secondary Areas](#);
- Limited use areas;
- Stairs;
- Staircase openings;
- Lift shafts;
- Other vertical penetrations.

Diagram 21 - IPMS 4.2 – Upper Level

If the areas of stairs, staircase openings, lift shafts and other vertical penetrations are included in the selected area, they should be stated separately.

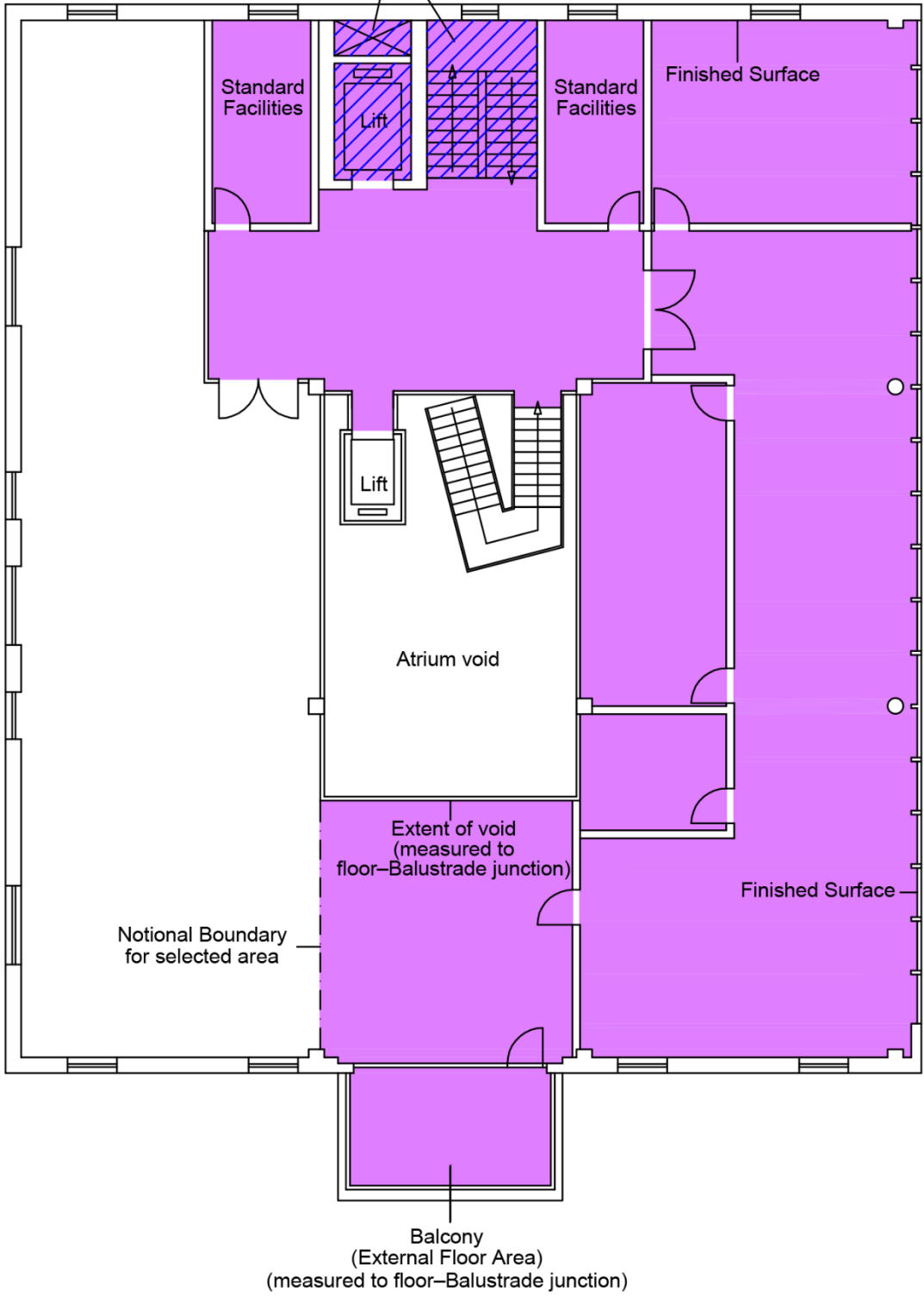

Part F: IPMS Coalition

The Coalition members at the date of publication include:

[American Society for Testing and Materials \(ASTM\)](#)
[American Society of Farm Managers and Rural Appraisers \(ASFMRA\)](#)
[Appraisal Foundation \(TAF\)](#)
[Appraisal Institute \(AI\)](#)
[Asia Pacific Real Estate Association \(APREA\)](#)
[Asian Association for Investors in Non-listed Real Estate Vehicles \(ANREV\)](#)
[Asociación de Consultoras Inmobiliarias \(ACI\)](#)
[Asociación de Promotores Constructores de España \(APCE\)](#)
[Asociación Española de Análisis de Valor \(AEV\)](#)
[Asociación Española de Geómetras Expertos \(AEGEX\)](#)
[Asociación Profesional de Sociedades de Valoración \(ATASA\)](#)
[Australian Property Institute \(API\)](#)
[British Property Federation \(BPF\)](#)
[Building Owners & Managers Association Canada \(BOMA Canada\)](#)
[Building Owners & Managers Association China \(BOMA China\)](#)
[Building Owners & Managers Association Indonesia \(BOMA Indonesia\)](#)
[Building Owners & Managers Association International \(BOMA International\)](#)
[Building Owners & Managers Association Japan \(BOMA Japan\)](#)
[Bulgarian Chamber of Professional Valuers \(KPO\)](#)
[China Institute of Real Estate Appraisers and Agents \(CIREA\)](#)
[Commonwealth Association of Surveying and Land Economy \(CASLE\)](#)
[Consiglio Nazionale Geometri e Geometri Laureati \(CNGeGL\)](#)
[CoreNet Global](#)
[Council of European Geodetic Surveyors \(CLGE\)](#)
[Council on Tall Buildings and Urban Habitat \(CTBUH\)](#)
[Counselors of Real Estate \(CRE\)](#)
[Cumbria Rural Enterprise Agency \(CREA\)](#)
[Cyprus Architects Association \(CAA\)](#)
[Cyprus Association of Civil Engineers \(CYACE\)](#)
[Cyprus Association of Quantity Surveyors and Construction Economists \(SEEOKK\)](#)
[Cyprus Federation of Building Contractors Associations \(OSEOK\)](#)
[Czech Banking Association \(CBA\)](#)
[Emirates Green Building Council \(EmiratesGBC\)](#)
[European Association of Real Estate Professions \(CEPI-CEI\)](#)
[European Mortgage Federation \(EMF\)](#)
[Facility Management Institute Slovakia \(FMIC\)](#)
[Federation of Real Estate Investment Experts \(Bundesverband der Immobilien-Investment-Expert \(BIIS\)\)](#)
[FM Institute Czech](#)
[Germany Property Federation \(ZIA\)](#)
[Ghana Institution of Surveyors \(GhIS\)](#)
[GRESB](#)
[HypZert](#)
[International Association of Assessing Officers \(IAAO\)](#)
[International Consortium of Real Estate Associations \(ICREA\)](#)
[Institute of Estate Agents \(IEA\)](#)
[Hungarian Real Estate Developers Association \(IFK\)](#)
[International Facility Management Association \(IFMA\)](#)
[International Facility Management Association – Poland \(IFMA\)](#)
[European Association for Investors in Non-Listed Real Estate Vehicles \(INREV\)](#)
[International Monetary Fund \(IMF\)](#)
[Institute of Philippines Real Estate Appraisers \(IPREA\)](#)
[Institute of Real Estate Management \(IREM\)](#)
[International Right of Way Association \(IRWA\)](#)
[Institution of Surveyors Kenya – ISK](#)
[International Federation of Surveyors \(FIG\)](#)
[International Real Estate Federation \(FIABCI\)](#)
[International Union of Property Owners \(UIPI\)](#)
[International Union of Tenants \(IUT\)](#)

[Israel IVS Forum](#)
[Italian Real Estate Industry Association \(ASSOIMMOBILIARE\)](#)
[Japan Association of Real Estate Counselors \(JAREC\)](#)
[Japanese Association of Real Estate Appraisers \(JAREA\)](#)
[Middle East Council of Shopping Centres \(MECSC\)](#)
[National Society of Professional Surveyors \(NSPS\)](#)
[National Union of Economists of Construction \(UNTEC\)](#)
[Nigerian Institution of Estate Surveyors and Valuers \(NIESV\)](#)
[Ordre des géomètres experts français \(OGE\)](#)
[Polish Green Building Council \(PGBC\)](#)
[Property Council of Australia \(PCA\)](#)
[Property Council New Zealand \(PCNZ\)](#)
[Property Institute of New Zealand \(PINZ\)](#)
[ProProgressio](#)
[Queensland Spatial & Surveying Association \(QSSA\)](#)
[Real Estate Institute of Botswana \(REIB\)](#)
[Real Estate Investments Zimbabwe \(REIZ\)](#)
[Real Estate Syndicate of Lebanon \(REAL\)](#)
[Real Property Association of Canada \(REALpac\)](#)
[Royal Institute of British Architects \(RIBA\)](#)
[Royal Institution of Chartered Surveyors \(RICS\)](#)
[Royal Society of Ulster Architects \(RSUA\)](#)
[South African Property Owners Association \(SAPOA\)](#)
[SECOVI – SP \(SECOVI\)](#)
[Society of Chartered Surveyors Ireland \(SCSI\)](#)
[Society of Office and Industrial Realtors \(SIOR\)](#)
[Society of Property Researchers, Germany \(GIF\)](#)
[Swiss Surveyors Association \(IGS\)](#)
[Technical Chamber of Cyprus \(ETEK\)](#)
[ULI Asia Pacific](#)

Part G: IPMS Standards Setting Committee

In July 2013 the IPMSC selected real estate experts from around the world to form its Standards Setting Committee (SSC) and develop global standards for property measurement.

The SSC brings together experts including academics, real estate fund and asset managers, valuers, and specialists in development and construction. The SSC acts independently from the Coalition and its respective members.

At the time of publication, the SSC members and co-authors of this standard for IPMS are:

Chairman: Peter L. Stevenson MBOMA, MRICS (USA)

Vice Chairman: Frederic Mortier MSc (Belgium)

Executive Secretary: Alexander Aronsohn FRICS (UK)

Allen Crawford FRICS, FAPI (Australia)

Max Crofts FRICS (UK)

Randal Froebelius P.Eng. (Canada)

Anthony Gebhardt MRICS, RQS (South Africa)

Dipl. Ing. Wolfgang Glunz REV (Germany)

Prof. Dipl. Ing. Marc Grief, (Germany)

Alex PW Leung MHKIS, MRICS, MCIREA (China)

Luke Mackintosh MRICS, AAPI, F Fin (Australia)

Howard Morley ANZIV, SNZPI, FREINZ, AAMINZ (New Zealand)

Tom Pugh FRICS (UK)

Nigel Sellars FRICS (UK)

Nicholas Stolatis CPM, RPA, LEED AP (USA)

Koji Tanaka FRICS, ACI Arb, RIBA, JIA (Japan)

Prof. Dario Trabucco PhD (Italy)

Prof. Dr.-Ing. Regina Zeitner (Germany)